



Gatwick Airport Northern Runway Project

Environmental Statement

Appendix 5.3.2: Code of Construction Practice – Annex 6: Outline Arboricultural and Vegetation

Method Statement – Part 1 – Tracked Version

Book 5

VERSION: 5.0

DATE: AUGUST 2024

Application Document Ref: 5.3

PINS Reference Number: TR020005



YOUR LONDON AIRPORT
Gatwick

Our northern runway: making best use of Gatwick

Environmental Statement
Appendix 5.3.2: Code of Construction Practice, Annex 6: Outline Arboricultural & Vegetation Method
Statement

| *August* ~~July~~ 2024

EXECUTIVE SUMMARY

This Outline Arboricultural & Vegetation Method Statement forms Annex 6 of Appendix 5.3.2: Code of Construction Practice of the Environmental Statement (ES). It provides details of arboricultural protection and mitigation measures for the Northern Runway Project in accordance with the BS5837:2012 standard.

The main purpose of this statement is to provide the necessary measures to protect any retained trees and vegetation during the construction works. The statement also specifies best working practices and methodologies to ensure responsible construction procedures for the protection and preservation of trees and other vegetation.

Preliminary plans for removing and protecting retained trees can be found in Appendices A and B. These plans identify which trees are likely to be retained or removed based on current designs, their approximate locations, and protection fence lines. The plans also identify the Root Protection Areas (RPA) for the retained trees, which inform protective measures during development.

Preliminary Vegetation Removal and Protection Plans are included in this report as Appendices C and D.

The arboricultural measures within this statement and its appendices will be revisited during the detailed design phase, ensuring that any tree or vegetation loss is necessary and that arboricultural considerations are seamlessly integrated into the overall project plans and reflect the latest on-site conditions.

Area-specific Detailed Arboricultural and Vegetation Method Statements including Detailed Vegetation Removal and Protection Plans and, where required, Detailed Tree Removal and Protection Plans will be prepared to be substantially in accordance with this Outline Arboricultural & Vegetation Method Statement, for approval by the relevant planning authority prior to the

relevant construction works commencing. The Detailed AVMSs will be prepared for all parts of the Project that coincide with existing trees and vegetation, or elements of the Project that lie immediately adjacent to trees and vegetation.

Contents

1	Introduction	2
2	Site Location	3 2
3	Ancient Woodland Protection	3
4	Detailed AVMS	3
5	Working Practices	4
6	Below Ground Impact Mitigation	6
7	Protection of Vegetation	8
8	References	<u>109</u>

Appendixes

Appendix A M23 & A23 Preliminary Tree Removal & Protection Plans

Appendix B Airport Preliminary Tree Removal & Protection Plans

Appendix C M23 & A23 Preliminary Vegetation Removal & Protection Plans

Appendix D Airport Preliminary Vegetation Removal & Protection Plans

Appendix E Example Tree Protection Fencing

Appendix F Example Construction Exclusion Zone (CEZ) Sign

Appendix G Example Ground Protection Detail

Appendix H Table of Trenchless Utility Installation

Appendix I Glossary of Arboricultural Terms

1 Introduction

1.1.1 This document forms Annex 6 of the Appendix 5.3.2: Code of Construction Practice of the Environmental Statement (ES) prepared on behalf of Gatwick Airport Limited (GAL) for the proposal to make best use of Gatwick Airport's existing runways and infrastructure (referred to within this report as 'the Project'). It is secured by DCO Requirement 28.

1.1.2 This outline statement has been informed by:

- The Tree Survey and Arboricultural Impact Assessment contained in ES Appendix 8.10.1 (Doc Ref 5.2), including the tree schedules and accompanying plans; and
- Ecology Survey Report ES Appendix 9.6.2.

1.1.3 This outline statement has been prepared in accordance with the requirements set out in BS5837:2012 'Trees in relation to design, demolition and construction – Recommendations.'¹

1.2 Scope of Report

1.2.1 This outline statement follows on from the Tree Survey and Arboricultural Impact Report that forms Appendix 8.10.1 of the Environmental Statement (ES).

1.2.2 This outline statement provides the following information:

- Arboricultural information and measures to ensure the protection of retained trees throughout the construction of the Project.
- Appendices A and B: Preliminary Tree Removal and Protection Plans to illustrate the proposed protection measures to be taken in respect of the

trees during construction of the Project identifying the following:

- Trees to be retained;
- Trees to be removed based on worst case scenario;
- Indicative alignment and design of protection fencing; and
- Root Protection Area (RPA) of trees.

1.2.3 Appendices C and D: Preliminary Vegetation Removal and Protection Plans to illustrate the proposed protection measures to be taken in respect of all vegetation during construction of the Project.

1.3 Implementation

1.3.1 Under DCO Requirement 28, prior to the removal of any vegetation or trees as part of the authorised development, a detailed Arboricultural and Vegetation Method Statements (AVMS) for that area must be submitted to and approved by CBC (following consultation with MVDC and RBBC as appropriate).

1.3.2 The AVMSs must include Detailed Vegetation Removal and Protection Plans and, where there are trees in the area, Detailed Tree Removal and Protection Plans.

1.3.3 The AVMSs including the detailed removal and protection plans must be substantially in accordance with this Outline Arboricultural and Vegetation Method Statement and the relevant plans in Appendices A to D.

1.3.4 The AVMSs including the plans must be implemented as approved throughout the time that

construction activities are being carried out under the DCO in that area unless otherwise agreed with CBC (following consultation with MVDC and RBBC as appropriate)

1.3.5 The arboricultural and vegetation protection measures within this statement and the Preliminary Tree Removal and Protection Plans and Preliminary Vegetation Removal and Protection Plans will be revisited during the detailed design phase in preparing the AVMSs ensuring that arboricultural and vegetation considerations are seamlessly integrated into the overall Project plans and reflect the latest on-site conditions.

1.3.6 The approved AVMSs including relevant Detailed Tree Removal and Protection Plans and Detailed Vegetation Removal and Protection Plans shall be available to all relevant site operatives prior to and throughout the construction process in the relevant areas, so they understand the scope and importance of the vegetation protection measures.

1.3.7 In particular, the establishment of a Construction Exclusion Zone (CEZ) by erection of Tree Protection Fencing will be required to minimise the potential for harm to occur to retained trees as will be specifically described in the approved AVMSs as appropriate.

~~1.3.7~~ 1.3.8 Each detailed AVMSs must include a Tree Works Schedule setting out the number of all existing trees to be removed and the species and trunk diameter (measured in cm at 1.5m above ground level) of each individual tree to be removed.

¹ British Standards Institute. British Standard (BS5837) Trees in Relation to Design, Demolition and Construction - Recommendations. 2012.

2 Site Location

- 2.1.1 The Project is located at London Gatwick Airport (LGW), Horley, Gatwick RH6 0NP.
- 2.1.2 The tree survey comprised of several areas in and around the airport grounds that correspond to the expected extent of the project.
- 2.1.3 The Local Planning Authorities (LPA) governing this site are Crawley Borough Council, Horsham District Council, Mole Valley District Council, Reigate and Banstead Borough Council and Tandridge District Council.
- 2.1.4 The soilscape of the area in which the survey site is situated typically consists of 'Slowly Permeable Seasonally Wet Slightly Acid but Base-Rich Loamy and Clayey Soils' with areas of 'Loamy and Clayey Floodplain Soils With Naturally High Groundwater' and 'Loamy Soils With Naturally High Groundwater'².
- 2.1.5 The land is roughly centred on OS grid reference TQ27144084.

2.2 Survey findings

- 2.2.1 The site was surveyed in two sections;
 - M23 and A23 airport approach roads and adjoining areas.
 - Airport and surrounding area.
- 2.2.2 Across the two sections, a total of 748 individual trees were surveyed, along with 359 groups, woodlands, hedges and scrub areas.
- 2.2.3 A further walkover survey was carried out in January 2024.

- 2.2.4 Please refer to the Tree Survey and Arboricultural Impact Assessment (AIA) contained in ES Appendix 8.10.1 (Doc Ref 5.2) for full survey findings.

3 Ancient Woodland Protection

- 3.1.1 A buffer zone of at least 15 metres will be provided around any areas of Ancient Woodland, measured from the boundary of the woodland. Within these buffers, no works will be carried out of any kind.
- 3.1.2 Where works are proposed adjacent to any Ancient Semi-Natural Woodlands (ASNW) buffers, additional fencing will be used, to ensure buffer zones remain construction exclusion zones at all times.
- 3.1.3 A 15m buffer zone has been shown on the Preliminary Tree Removal and Protection Plans around all four ASNW identified within the AIA. The buffer zones of two of these fall outside of any proposed works and so have not been considered any further within this report.
- 3.1.4 Two of these ASNW buffers fall within the project boundary and are located adjacent to proposed works:

3.2 Brockley Woods

- 3.2.1 Brockley Wood is adjacent to a proposed on-airport road and the River Mole improvement works, however, no works will take place inside the 15m ASNW buffer.
- 3.2.2 Additionally, the 15m ASNW buffer around Brockley Wood will be fenced off from works, as shown on the Preliminary Tree Removal and Protection Plans.

3.3 Horleyland Woods

- 3.3.1 Horleyland Wood is adjacent to the proposed surface water/foul water works. The indicative alignment of the underground services is located outside of the 15m ASNW buffer zone (See Appendix B).
- 3.3.2 Additionally, Hi-Viz mesh fencing will be installed between construction activities and the woodland along the 15m ASNW buffer line to ensure there is no impact upon the woodland. See Appendix E for fence detail design.

4 Detailed AVMS

- 4.1.1 Prior to the removal of any vegetation or trees, a detailed AVMS for that area must be submitted to and approved by CBC (following consultation with MVDC and RBBC as appropriate). The AVMS will include Detailed Vegetation Removal and Protection Plans and, where there are trees in the area, Detailed Tree Removal, Protection Plans and Tree Work Schedules as needed.
- 4.1.2 These must all be substantially in accordance with this oAVMS and its appendices.
- 4.1.3 The Detailed Vegetation Removal and Protection Plans for each area will show:
 - Locations of vegetation to be retained.
 - Locations and alignments of vegetation protection fencing.
 - The locations of all vegetation to be removed

[4.1.4 Where individual trees for removal have been collectively referenced within the survey, these](#)

² <https://magic.defra.gov.uk/MagicMap.aspx>

[trees will be referenced separately within the Tree Works Schedules to be contained in the detailed AVMSs, using decimal places to differentiate between each individual tree \(i.e. T1.1, T1.2\).](#)

4.1.4.1.5 The Detailed Tree Removal and Protection Plans for each area will be substantially in accordance with the preliminary plans in Appendix A and will show:

- Locations of trees to be retained with RPAs and approximate tree canopy outlines with category colours.
- Locations and alignments of tree protection fencing.
- Hatches/ comments showing where specific tree working methodologies are required (which will be detailed in the key).

4.1.5.1.6 These hatches and any comments will be further expanded upon within the body of the related Detailed AVMS.

5 Arboricultural Working Practices

5.1.1 The measures set out in this section are arboricultural working procedures and protective measures that will, following detailed design, be reviewed and confirmed through the Detailed AVMSs. They only apply in relation to trees and the more generic protective measures required for all other vegetation are set out in section 7 of this report.

5.1.2 This oAVMS is an appendix to the CoCP (Doc Ref. Appendix 5.3.2). Any construction activities must be carried out in accordance with the CoCP under DCO Requirement 7.

5.1.3 Alongside the detailed AVMSs, the CoCP includes a number of other construction management measures for the protection of trees and vegetation which must be implemented.

5.2 Outline of Working Practises

5.2.1 General Working Practises and Methodologies that will be implemented across site are as follows:

- General Methodology for Working Near Trees (section 5.3)
- Tree Removal and Pruning Works (section 5.4)
- Tree Protection Measures (section 5.6)

5.2.2 More specific Arboricultural Working Practices may be required in specific areas and will be included within the relevant detailed AVMS submitted for approval. These specific Arboricultural Working Practices are described in Section 6 and listed below:

- Excavation within an RPA
- Breaking out Existing Hard Surface
- Resurfacing of Existing Hard Surfaces
- Construction of New Hard Surfaces
- Installation of Posts for Fencing
- Ground Protection
- Installing New Surfaces or Upgrading Existing Services.

5.3 General Methodology for Working Near Trees

5.3.1 Where possible, all new (and existing re-routed) services shall be routed outside the existing or potential RPA of retained trees. Where it is unavoidable, then hand excavation shall be employed to avoid damage to the larger roots and the services slid through or below the root system. Ducting shall be used to carry cables. Reference

shall be made to the recommendations included within Guidelines for the Planning, Installation and Maintenance of Utility Apparatus in Proximity to Trees (NJUG 4)³.

5.3.2 Where reasonably practicable, RPAs of all retained trees will become exclusion zones during construction works, and for any development, unless they have specific works and accompanying methodology, that is specified within the Detailed AVMS.

5.3.3 RPAs will be fenced-off and protected in accordance with BS5837:2012. Details of Tree Protection Fencing and ground protection are given in Section 5.5 of this document.

5.3.4 Unless specified within the Detailed AVMS, there will be no activities that result in excavations, changes in level or soil compaction within the RPA of any retained trees, especially older mature trees. This includes the storage of materials, any construction work, trafficking by vehicles or even excessive trafficking by pedestrians.

5.3.5 The location and siting of proposed new construction elements near trees will consider the potential impact on and conflict with both tree roots and canopy. This will consider the ultimate size of existing young and middle-aged trees at maturity.

5.3.6 Conversely, the impact of the tree/s on end user activities will also be considered with regard to obstruction, shading, leaf fall and root action. These are problems that can be managed provided sufficient space is allowed for.

³ <http://streetworks.org.uk/wp-content/uploads/V4-Trees-Issue-2-16-11-2007.pdf>

5.3.7 If works are to encroach upon a trees RPA and arboricultural supervision is required, this will be noted in the Detailed AVMS.

5.3.8 If however, any roots greater than 25mm diameter are discovered while working outside of a trees RPA, arboricultural advice shall be sought before works continue.

5.4 Tree Removal and Pruning Works

Standard of Work

5.4.1 The tree work required in order to facilitate the Project will adhere to the following standards:

- All tree works shall be carried out in accordance with BS3998:2010 and latest arboricultural best practice.
- All tree work shall be carried out by suitably qualified, competent and insured arboricultural contractors in accordance with Arboricultural Association Standard Conditions of Contract and Specifications for Tree Works (2008) Edition and BS 3998:2010 Tree Work.
- All green and woody waste generated by the tree work will be managed in accordance with the principles set out in the Construction Resources and Waste Management Plan and the Site Waste Management Plan.

5.4.2 When a branch is removed at its point of attachment, injury of the wood and bark of the parent stem or branch above the cut shall be avoided. If a branch collar is visible, the final cut shall be just outside it and care shall be taken to avoid tearing retained wood and bark when the cut is made. Preliminary cuts shall be made, if necessary, so as to remove weight, before a final cut is made. Care shall be taken to prevent falling branches from harming other parts of the tree

(including its roots), its surroundings, people or property. Heavy branches shall be removed in sections and, where necessary, shall be lowered with ropes.

5.4.3 Prior to the start of any tree works, an appropriate risk assessment shall be carried out by the appointed contractor to describe the measures required to fulfil the statutory safety obligations. It shall identify and prioritise the necessary control measures and precautions.

Timing of Works

5.4.4 Any tree works required shall be completed in accordance with the relevant Detailed AVMS.

5.4.5 All works shall be timed to have regard to the phenological cycles of protected species that are associated with trees; notably birds and bats.

5.4.6 Please refer to ES Appendix 5.3.2: Code of Construction Practice (Doc Ref. 5.3) for further details regarding the protection of birds during tree removal.

Young Tree Transplantation

5.4.7 Where practicable young trees that have been identified for removal will be translocated rather than felled.

5.4.8 Suitable trees for transplantation will be identified on the detailed Tree Protection Plans within the detailed AVMS.

5.5 Tree Protection Measures

Construction Exclusion Zones

5.5.1 The protection fence line defines the Construction Exclusion Zone (CEZ), and the fencing shall not be moved or taken down at any time whilst the construction activities are being carried out.

5.5.2 Within the CEZ, unless specified otherwise within the Detailed AVMS, there must be no mechanical digging or scraping; no alteration to existing ground levels including soil stripping; no earthworks; and no handling or discharge of any chemical substance, concrete washings or of any fuels. Furthermore, vehicular, or pedestrian access and the storage of any materials is prohibited within the CEZ.

5.5.3 Additionally, no materials that may contaminate the soil such as concrete mixings, diesel oil and vehicle washings shall be discharged within 10m of the stem of any tree and no fires shall be lit within 10m of the maximum extent of a trees crown.

Tree Protection Fencing

5.5.4 Unless otherwise agreed in writing with the Arboricultural Consultant, the fencing system to be utilised shall be in accordance with Appendix E and compliant with BS5837:2012.

5.5.5 The tree protection fence shall be erected as shown on the Detailed Tree Removal and Protection Plans which will form part of the Detailed AVMSs. The Detailed Tree Removal and Plans must be substantially in accordance with Appendices A and B as appropriate.

5.5.6 The fence line to be shown on the Detailed Tree Removal and Protection Plans will be shown as the minimum required and the length of the fence shall be extended or adjusted on site as agreed with the Arboricultural Consultant to ensure satisfactory protection of all retained trees and RPAs.

5.5.7 Where proposed construction site-hoarding provides the same level of protection to the retained trees and RPAs as the proposed tree protection fence, subject to agreement with the Arboricultural Consultant, the hoarding may serve as the tree protection fence. Notwithstanding, depending on

the form and alignment of the construction site- hoarding it may be necessary to provide additional tree protection fence to ensure adequate protection of retained trees and RPAs as shown on the Detailed Tree Removal and Protection Plans.

- 5.5.8 Where necessary, tree protection fencing may be temporarily re-aligned in order to facilitate tree removal. Fencing is to be re-instated immediately following removal in a manner that encompasses the remaining trees and their respective RPAs.
- 5.5.9 During tree removal, no wheeled or tracked machinery is to enter the area previously encompassed by tree protective fencing as shown in the Detailed Tree Removal and Protection Plans.
- 5.5.10 Signs detailing the purpose of the protective fencing shall be attached to the fencings. Such signs will be weatherproof and shall be substantially in the form of the specimen provided in Appendix F. Signs must be replaced as necessary if they are removed or have become illegible.

Site Compounds and Materials Stores

- 5.5.11 Activities related to the establishment of a temporary site compound have the potential to impact upon retained trees by various means. In particular the storage and mixing of chemicals and materials such as concrete can have a damaging effect on tree health if precautions are not taken.
- 5.5.12 To prevent harm occurring to trees, provision for materials storage, deliveries and other related activities shall be made available in areas away from retained trees.
- 5.5.13 Under no circumstances shall materials or plant be stored beneath the canopy or within or abutting the RPA of any retained trees/hedges, whether fenced or not.

Soft Landscaping

- 5.5.14 All landscaping works shall take place from outside any area demarcated as a CEZ, even after any protective fencing has been removed.
- 5.5.15 Where final landscape grading will require fathering into the CEZ, this works shall be done by hand or by use of small plant, preferably with large pneumatic grass tyres.
- 5.5.16 All soft landscaping works shall be in accordance with the relevant Landscape and Ecology Management Plan which must be substantially in accordance with the oLEMP (under DCO Requirement 8). This includes reference to good horticultural practice and current British Standards with particular reference to:
 - **BS 3998:** Recommendations for tree work
 - **BS 4428:** Code of practice for general landscape operations
 - **BS 7370:** Grounds maintenance

Dust Management

- 5.5.17 During particularly hot, dry weather conditions, dust created from certain construction activities can cover tree canopies and subsequently cause indirect damage to trees by reducing transpiration through the leaves and their ability to photosynthesise.
- 5.5.18 Dust management measures are set out throughout the CoCP and especially in section 5.8. Any construction activities must be carried out in accordance with the CoCP.
- 5.5.19 If any works adjacent to retained trees causes dust to settle on the canopies of trees, a water hose shall be used to water down and remove all dust from leaves within the canopy.

Monitoring

- 5.5.20 Following erection of the protection fencing and prior to commencement of the construction works of the relevant area, an inspection of the site by the Arboricultural Consultant will be arranged to confirm fencing has been installed in accordance with the Detailed Tree Removal and Protection Plans (to be prepared as part of the Detailed AVMSs).
- 5.5.21 Further monitoring visits will be carried out following commencement of the works on site, to ensure ongoing functionality of the CEZ and to check on tree condition.
- 5.5.22 All arboricultural site visits will be recorded within an Arboricultural Inspection Report (AIR).

Reporting

- 5.5.23 Should any arboricultural issues become apparent during the works, such as finding large roots outside of an RPA or accidental damage to a retained tree; the Principal Contractor will immediately contact the Arboricultural Consultant for advice on how to proceed.

6 Below Ground Arboricultural Mitigation

- 6.1.1 As part of the detailed design phase, any essential works that are identified within the RPA of a retained tree will require extra protection or mitigation methods.
- 6.1.2 Areas where such additional mitigation methods are required will be set out in the Detailed AMVS and, where relevant, shown on the Detailed Tree Removal and Protection Plans subject to CBC's approval.
- 6.1.3 These mitigation methods may include the following:

Ground Protection

- 6.1.1 If access to a retained trees RPA is required in order to facilitate construction, the Detailed AVMS will identify this and specify where ground protection must be used in order to protect the trees roots from soil compaction.
- 6.1.2 Temporary ground protection must be sufficient in design, to support the proposed construction movement within the RPA. Different levels of ground protection may be comprised of one of the following designs as referenced from BS5837:2012:
- Pedestrian movements only: a single thickness of scaffold boards placed either on top of a driven scaffold frame, so as to form a suspended walkway, or on top of a compression-resistant layer (e.g. 100mm depth of woodchip), laid onto a geotextile membrane;
 - For pedestrian-operated plant up to a gross weight of 2t: proprietary, inter-linked ground protection boards placed on top of a compression-resistant layer (e.g. 150mm depth of woodchip), laid onto a geotextile membrane;
 - For wheeled or tracked construction traffic exceeding 2t gross weight: an alternative system (e.g. proprietary system or pre-cast reinforced concrete slabs) to an engineering specification designed in conjunction with arboricultural advice, to accommodate the likely loading to which it will be subjected.
- 6.1.3 See Appendix G for an Example Ground Protection Detail.

Excavation within an RPA

- 6.1.4 Where excavation works within the RPA are unavoidable, works must be undertaken by hand and the soil levels will be carefully reduced to avoid damage to the bark of larger roots directly beneath and adjacent to the excavation.
- 6.1.5 Where roots are found during any excavation, they shall not be left exposed for longer than 24hrs without sufficient root protection e.g. roots wrapped in wet hessian and faces of trenches covered with polyethylene material pinned down to the ground - especially important in hot and dry conditions. Hessian and any polyethylene shall be removed on backfilling of the trench.
- 6.1.6 Where root pruning is unavoidable it will be made at a suitable place within the root system, avoiding damage to surrounding tissue in accordance with BS 3998:2010⁴. Final pruning cuts shall be made at right angles to the axis of the root and the final cut wound will be smooth and as small as possible, free from ragged torn ends.
- 6.1.7 Roots smaller than 25mm diameter may be pruned back using a sharp and clean cutting tool such as secateurs or handsaws. Roots larger than 25mm should only be cut having first consulted the project Arborist as the roots maybe essential to the tree's health and stability.

Breaking Out Existing Hard Surface

- 6.1.8 Removal of any hard surface, within the RPA of a retained tree, shall be carried out by low impact handheld pneumatic tools. Working from the undisturbed surface, the removal of this surface shall occur in strips, working in a retreating manner away from the retained trees. Subsequent removal

of arisings / debris shall also be carried out by hand.

- 6.1.9 Where possible, the use of machines with a long reach will be favoured, if they can work from outside of the RPA's or from within the RPA's when supported by suitable ground protection.
- 6.1.10 Where this is not possible, hardstanding shall be manually broken up and removed from the RPA using appropriate hand tools e.g. pneumatic breaker, crowbar, sledgehammer, pick, mattock, shovel, spade, trowel and wheelbarrow. This work will also be carried out under an Arboricultural Watching Brief, to ensure any encountered roots are dealt with appropriately.

Resurfacing of Existing Hard Surface

- 6.1.11 Where this is proposed within an RPA, the new hard surface will be constructed using "No-dig" design principles, in accordance with AA Guidance Note 12 Cellular Confinement Systems Near Trees, with construction utilising existing levels, reusing sub-base and wearing courses within new construction.

Construction of New Hard Surface

- 6.1.12 Where possible, proposed new hard surface within any RPA will be constructed using above ground construction, requiring "No-dig" design principles in accordance with AA Guidance Note 12 Cellular Confinement Systems Near Trees, in order to minimise the potential impact this will have on any retained trees.

Installation of posts for fencing

- 6.1.13 At various points across the project there may be site hoarding/ boundary fences proposed within the

⁴ British Standards Institute. British Standard (BS3998) Trees Work - Recommendations. 2010.

RPAs of retained trees. The impact of this work is minimal and will not have a significant impact on tree health as long as best practise is followed.

- 6.1.14 Posts wherever possible shall be driven into the ground avoiding any obvious large surface roots. If it is not possible to drive post into the ground, small holes can be excavated using hand tools only, avoiding roots, back filled with removed earth and compacted down to ensure stability.
- 6.1.15 If cement is required to provide reinforcement, the hole shall be dug using hand tools only, lined with a non-permeable layer and cement poured into the hole to ensure the leaching of chemicals into the RPA does not occur.

Installing New Services or Upgrading Existing Services

- 6.1.16 Where practicable, all new surfaces will be outside of RPAs, but where existing services within RPAs require upgrading or new provision is required, trenchless installation will be the preferred option.
- 6.1.17 If this option is not feasible, any excavation will be carried out by hand in accordance with the guidelines set out in NJUG Volume 4 – Guidelines for the Planning, Installation and Maintenance of Utility Apparatus in Proximity to Trees.
- 6.1.18 The table in Appendix H taken from BS5837:2012 outlines available trenchless solutions.

7 Protection of Vegetation

- 7.1.1 In addition to tree protective measures, there are proposed protective measures for other important vegetation on site, such as (but not limited to):
 - Watercourses/ waterbodies
 - Marshy Grassland/ Neutral Grassland
 - Scrub

7.1.2 Where this vegetation is not already protected by Tree Protection Fencing and requires additional protective fencing, this will be shown on the Preliminary Vegetation Removal & Protection Plans, to be submitted at Deadline 4 and then in the Detailed Vegetation Removal and Protection Plans which will form part of the Detailed AVMS..

7.1.3 The area behind this protective fencing shall become a CEZ throughout any and all construction and development.

Construction Exclusion Zones

7.1.4 The protection fence line defines the Construction Exclusion Zone (CEZ), and the fencing shall not be moved or taken down at any time whilst the construction activities are being carried out.

7.1.5 Within the CEZ, unless specified otherwise within the Detailed AVMS, there must be no mechanical digging or scraping; no alteration to existing ground levels including soil stripping; no earthworks; and no handling or discharge of any chemical substance, concrete washings or of any fuels. Furthermore, vehicular, or pedestrian access and the storage of any materials is prohibited within the CEZ.

7.1.6 Additionally, no materials that may contaminate the soil such as concrete mixings, diesel oil and vehicle washings shall be discharged within 10m of any area where vegetation is fenced off and no fires shall be lit within 10m of any retained vegetation.

Vegetation Protection Fencing

7.1.7 The vegetation protection fence shall be erected as shown on the Detailed Vegetation Removal and Protection Plans which will form part of the Detailed AVMSs which will be approved by CBC. The Detailed Vegetation Removal and Plans must be

substantially in accordance with Appendices C and D as appropriate.

7.1.8 The fence line to be shown on the Detailed Vegetation Removal and Protection Plans will be shown as the minimum required and the length of the fence shall be extended or adjusted on site as agreed with the Arboricultural Consultant to ensure satisfactory protection of all retained vegetation.

7.1.9 Where proposed construction site-hoarding provides the same level of protection to the retained vegetation as the proposed vegetation protection fence, subject to agreement with the Arboricultural Consultant, the hoarding may serve as the vegetation protection fence. Notwithstanding, depending on the form and alignment of the construction site- hoarding it may be necessary to provide additional vegetation protection fence to ensure adequate protection of retained vegetation as shown on the Detailed Vegetation Removal and Protection Plans.

7.1.10 Where necessary, protective fencing may be temporarily re-aligned in order to facilitate tree or vegetation removal. Fencing is to be re-instated immediately following removal in a manner that encompasses the remaining vegetation, trees and their respective RPAs.

7.1.11 During any removal, no wheeled or tracked machinery is to enter the area previously encompassed by protective fencing as shown in the Detailed Tree Removal and Protection Plans.

Soft Landscaping

7.1.12 All soft landscaping works shall be in accordance with the relevant Landscape and Ecology Management Plan which must be substantially in accordance with the oLEMP (under DCO Requirement 8). This includes reference to good

horticultural practice and current British Standards with particular reference to:

- **BS 3998:** Recommendations for tree work
- **BS 4428:** Code of practice for general landscape operations
- **BS 7370:** Grounds maintenance

7.1.13 All landscaping works shall take place from outside any area demarcated as a CEZ, even after any protective fencing has been removed.

- 7.1.14 Where final landscape grading will require fathering into the CEZ, this works shall be done by hand or by use of small plant, preferably with large pneumatic grass tyres.

Monitoring

- 7.1.15 Following erection of the protection fencing and prior to commencement of the construction works of the relevant area, an inspection of the site by the Arboricultural Consultant will be arranged to confirm fencing has been installed in accordance with the Detailed Vegetation Removal and Protection Plans (to be prepared as part of the Detailed AVMSs).
- 7.1.16 Further monitoring visits will be carried out following commencement of the works on site, to ensure ongoing functionality of the CEZ and to check on tree condition.
- 7.1.17 All site visits will be recorded within an Arboricultural Inspection Report (AIR).

8 References

- British Standards Institute, BS5837:2012 Trees in relation to design, demolition and construction – Recommendations.
- British Standards Institute, BS3998:2010 Trees Work - Recommendations.
- NJUG Volume 4- Guidance for the planning, installation and maintenance of utility services in proximity of trees, 2007
- Arboricultural Association, Standard Conditions of Contract and Specifications for Tree Works (2008) Edition
- Arboricultural Association, Guidance Note 12 Cellular Confinement Systems Near Trees.

Appendix A
M23 & A23 Preliminary Tree Removal & Protection Plans

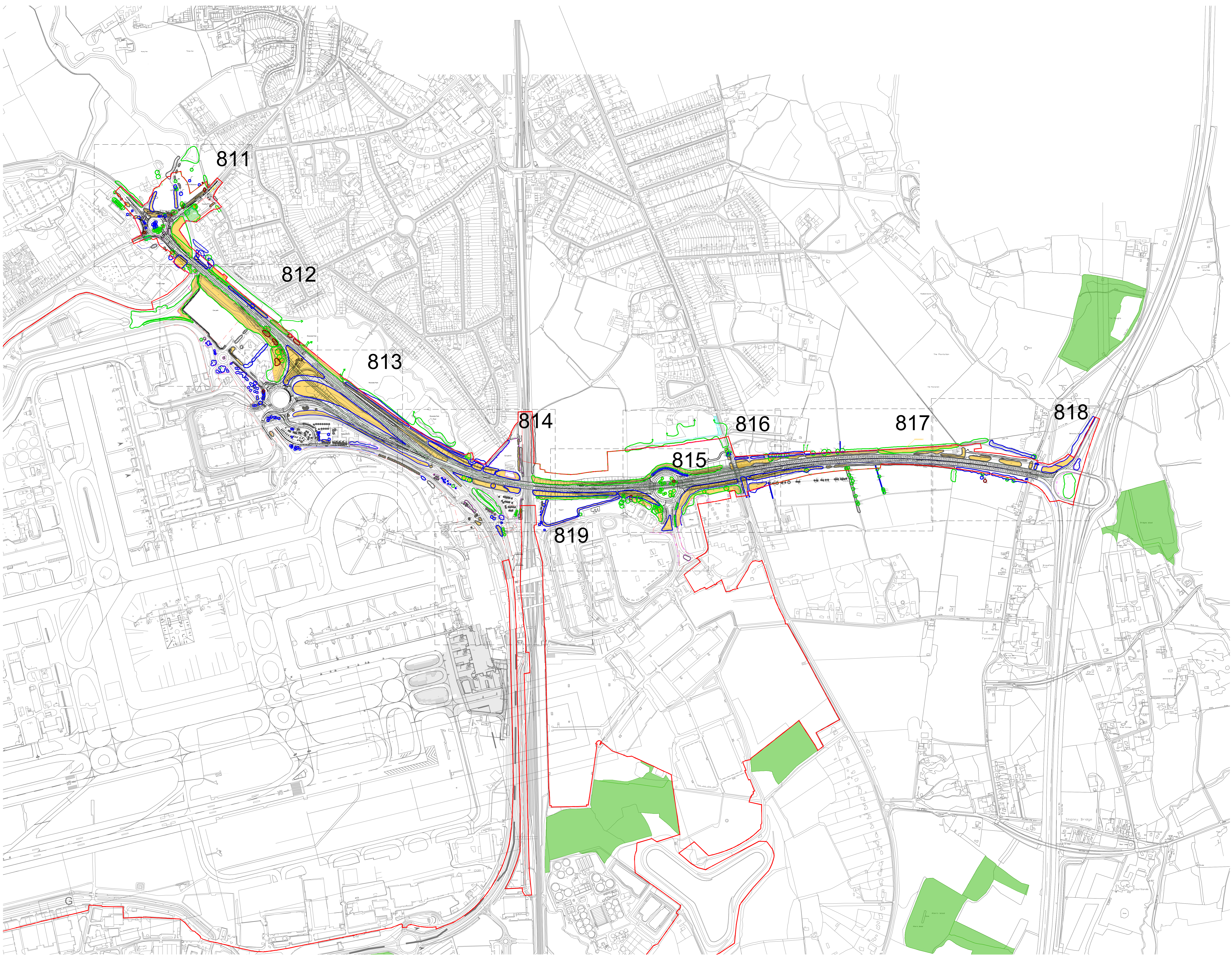

Key

- Site Boundary
- Survey Boundary / Boundary of M23/A23 construction activity
- Indicative temporary protective fence line in accordance with Section 6.2 - BS5837:2012. See below for example barriers.
- Indicative vegetation protective fence line: Design and location to be agreed by local council during detail design.
- Projected tree loss required for construction of the Project (worst case scenario)
- Tree with numbered reference. Canopy spread and coloured BS5837:2012 tree quality category as shown below.
 - = Tree details estimate (accessible tree)
 - = Tree in off site location
- Vegetation group with numbered reference. Canopy extent and BS5837:2012 tree quality category as shown below.
- Hedge with numbered reference. Width and BS5837:2012 tree quality category as shown below.

BS 5837:2012 Tree Quality Categories - Table 1

- Category A - High quality
- Category B - Moderate quality
- Category C - Low quality
- Category U - Unsuitable for retention

Tree protected by Tree Preservation Order. Bracketted number relates to the TPO reference.

NOTE:

- Refer to ES Appendix 8 to 11: Tree Survey report and Arboricultural Impact Assessment for further details.

DETAIL A
 Sectional illustration for protective barrier. Tree preservation order (TPO) reference: [bracketed number].

DETAIL B
 Sectional illustration for protective barrier. Tree preservation order (TPO) reference: [bracketed number].

Figure 1 - Examples of management solutions. Tree preservation order (TPO) reference: [bracketed number].

DOCUMENT

Environmental Statement

DRAWING TITLE
M23 & A23 Preliminary Tree Removal & Protection Plans Appendix 5.3.2 Annex 6 Overview

DATE
 August 2024

ORIENTATION	DRAWING NO.	REVISION
N	810	For ES Issue
	DRAWN BY	PM / CHECKED BY
	RC	DC

SCALE @ A0
 Custom Scale

Key

- Site Boundary
- Survey Boundary / Boundary of M23/A23 construction activity
- Indicative temporary protective fence line in accordance with Section 6.2 - BS5837:2012. See below for example barriers.
- Indicative vegetation protective fence line: Design and location to be agreed by local council during detail design.
- Projected tree loss required for construction of the Project (worst case scenario)
- Tree with numbered reference. Canopy spread and coloured BS5837:2012 tree quality category as shown below.
○ = Tree details estimate (inaccessible tree)
● = Tree in off site location
- Vegetation group with numbered reference. Canopy extents and BS5837:2012 tree quality category as shown below.
- Hedge with numbered reference. Width and BS5837:2012 tree quality category as shown below.

BS 5837:2012 Tree Quality Categories - Table 1

- Category A - High quality
- Category B - Moderate quality
- Category C - Low quality
- Category U - Unsuitable for retention

Tree protected by Tree Preservation Order. Bracketted number relates to the TPO reference.

NOTE:
Refer to ES Appendix 8 to 10: Tree Survey report and Arboricultural Impact Assessment for further details.

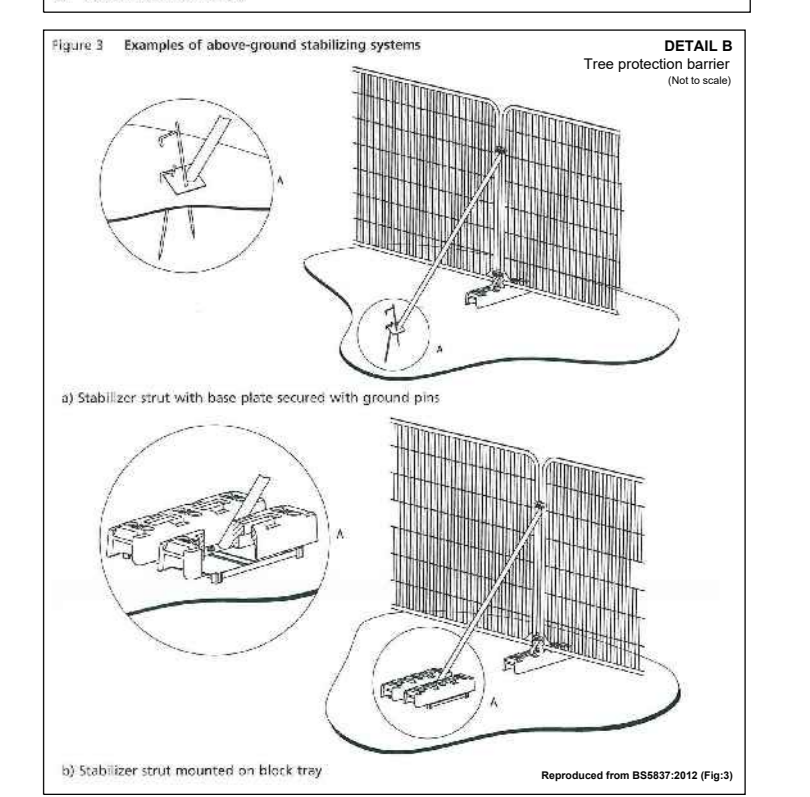
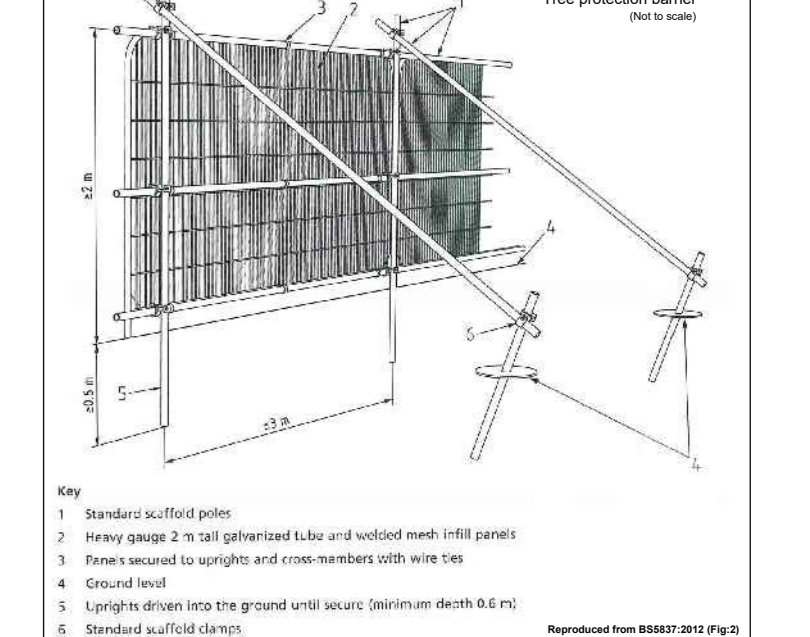

Key Plan

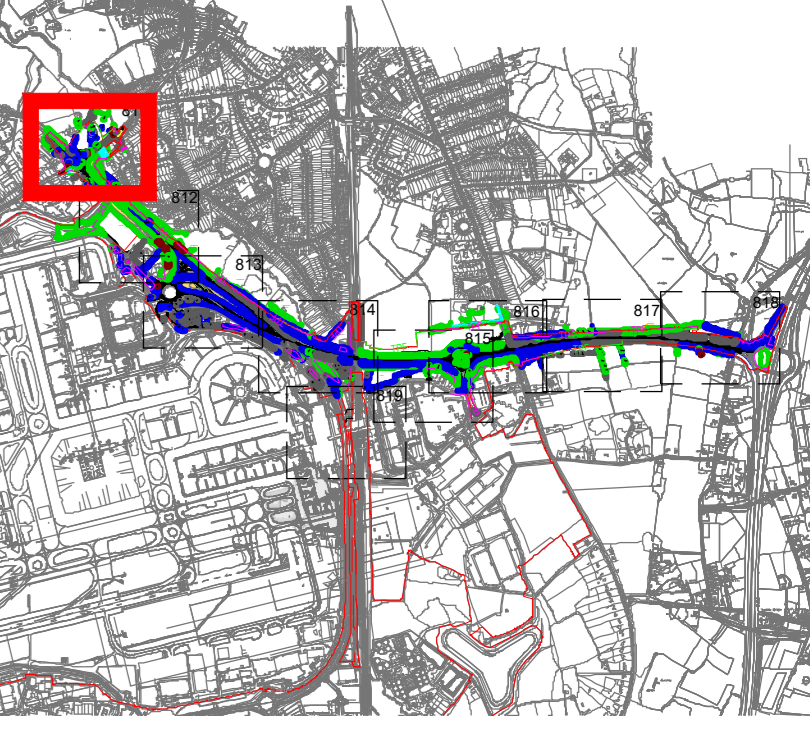

DOCUMENT

Environmental Statement

DRAWING TITLE
M23 & A23 Preliminary Tree Removal & Protection Plans
Appendix 5.3.2 Annex 6
Sheet 1 of 9

DATE: August 2024

ORIENTATION	DRAWING NO.	REVISION
N	811	For ES Issue
	DRAWN BY	PM / CHECKED BY
	RC	DC

SCALE @ A0
0m 25m 50m

Reproduced from Ordnance Survey map with the permission of Ordnance Survey on behalf of the controller of Her Majesty's Stationery Office © Crown Copyright (2023). License number 010031073, 10001998, 100048492.
© Copyright 2023 Gatwick Airport Limited. No part of this drawing is to be reproduced without prior permission of Gatwick Airport Limited.

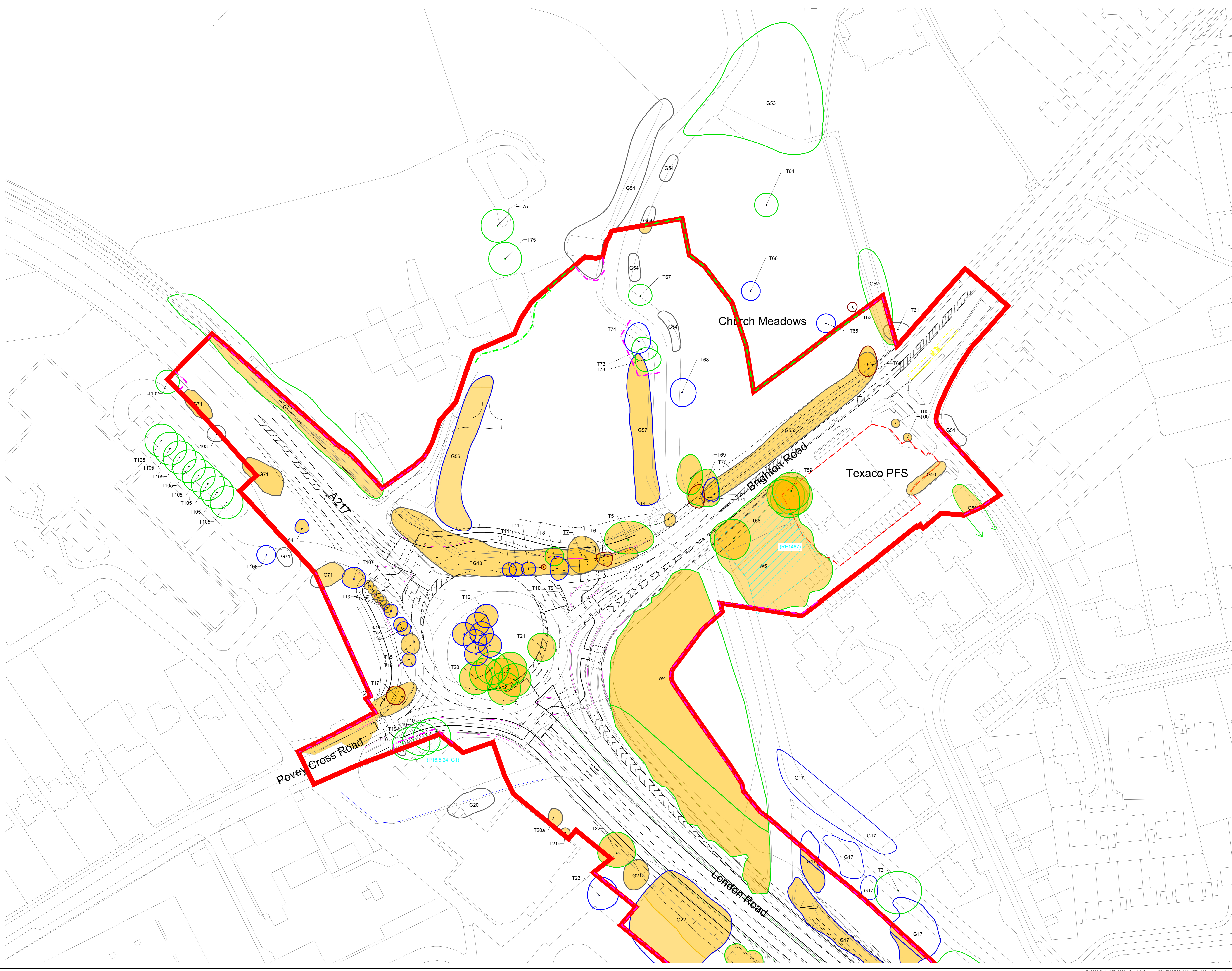

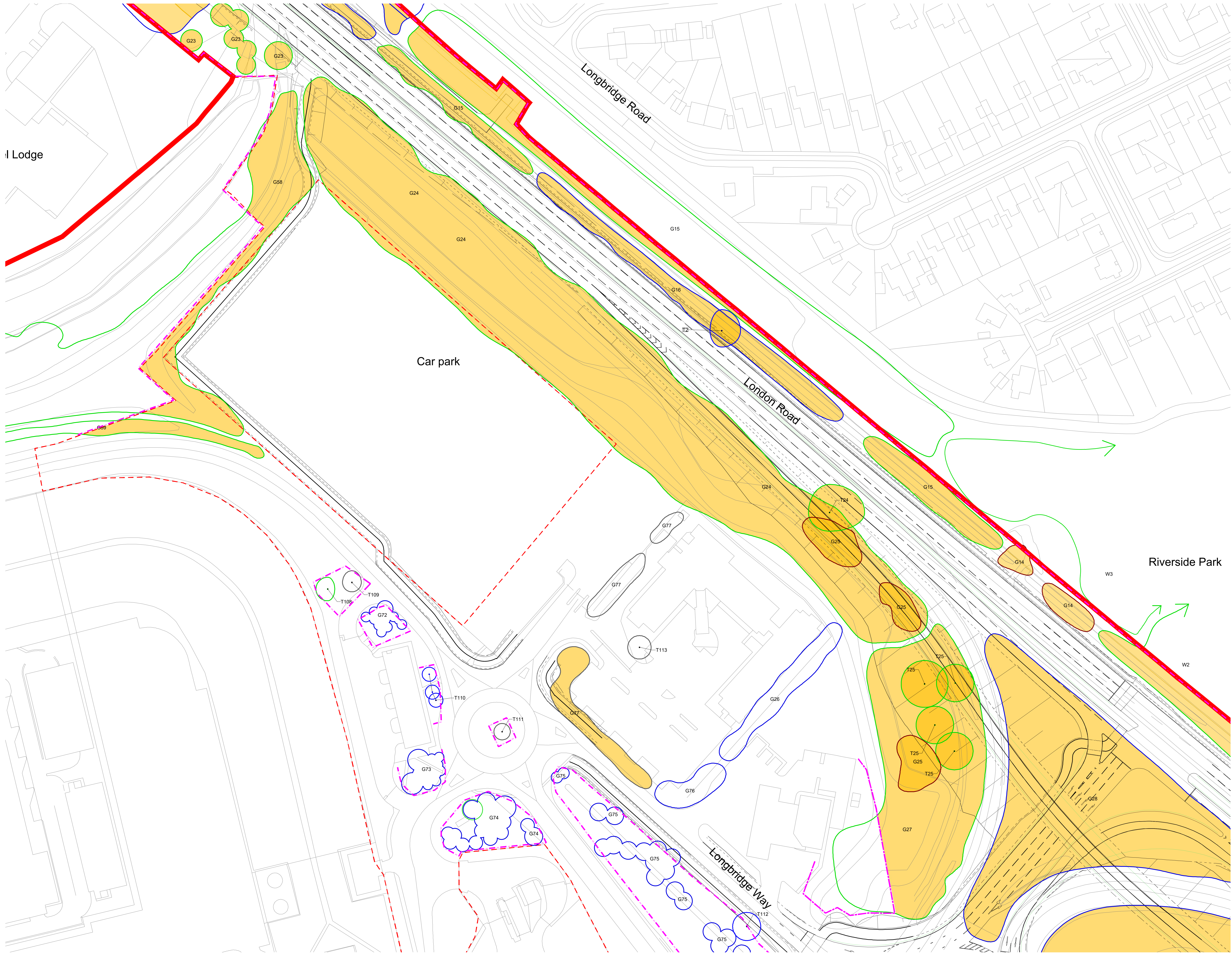

l Lodge

Car park

Riverside Park

Key

- Site Boundary
- Survey Boundary / Boundary of M23/A23 construction activity
- Indicative temporary protective fence line in accordance with Section 6.2 - BS5837:2012. See below for example barriers.
- Indicative vegetation protective fence line: Design and location to be agreed by local council during detail design.
- Projected tree loss required for construction of the Project (worst case scenario)
- Tree with numbered reference. Canopy spread and coloured BS5837:2012 tree quality category as shown below.
 - Tree details estimate (inaccessible tree)
 - Tree in off site location
- Vegetation group with numbered reference. Canopy extents and BS5837:2012 tree quality category as shown below.
- Hedge with numbered reference. Width and BS5837:2012 tree quality category as shown below.

BS 5837:2012 Tree Quality Categories - Table 1

- Category A - High quality
- Category B - Moderate quality
- Category C - Low quality
- Category U - Unsuitable for retention

Tree protected by Tree Preservation Order. Bracketted number relates to the TPO reference.

NOTE:

- Refer to ES Appendix 8 to 1: Tree Survey report and Arboricultural Impact Assessment for further details.

DETAIL A

DETAIL B

DETAIL C

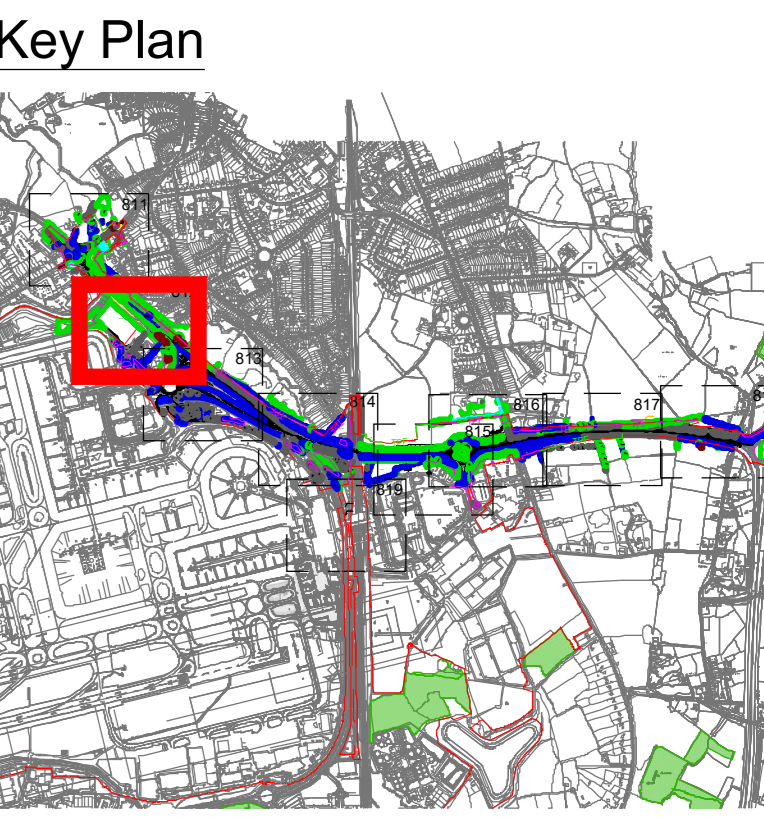

DOCUMENT

Environmental Statement

DRAWING TITLE
M23 & A23 Preliminary Tree Removal & Protection Plans
Appendix 5.3.2 Annex 6
Sheet 2 of 9

DATE
August 2024

ORIENTATION	DRAWING NO.	REVISION
N	812	For ES Issue
	DRAWN BY	PM / CHECKED BY
	RC	DC

SCALE @ A0
0m 25m 50m

Reproduced from Ordnance Survey map with the permission of Ordnance Survey on behalf of the controller of Her Majesty's Stationery Office © Crown Copyright (2023). License number 610031673, 10004988, 10004989.
© Copyright 2023 Gatwick Airport Limited. No part of this drawing is to be reproduced without prior permission of Gatwick Airport Limited.

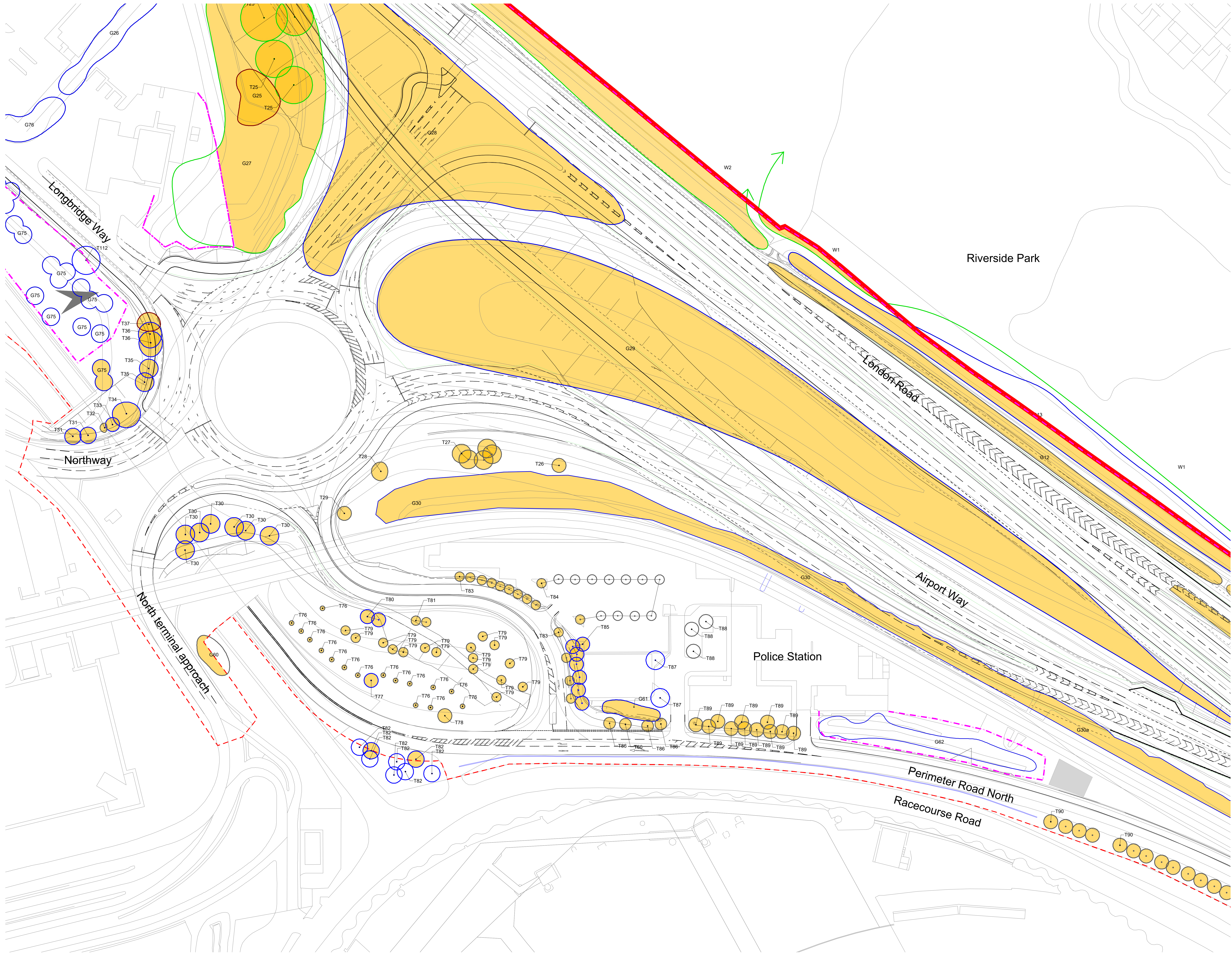

Key

- Site Boundary
- Survey Boundary / Boundary of M23/A23 construction activity
- Indicative temporary protective fence/line in accordance with Section 6.2 - BS5837:2012. See below for example barriers.
- Indicative vegetation protective fence/line: Design and location to be agreed by local council during detail design.
- Projected tree loss required for construction of the Project (worst case scenario)
- Tree with numbered reference. Canopy spread and coloured BS5837:2012 tree quality category as shown below.
 - = Tree details estimate (accessible tree)
 - = Tree in off site location
- Vegetation group with numbered reference. Canopy extents and BS5837:2012 tree quality category as shown below.
- Hedge with numbered reference. Width and BS5837:2012 tree quality category as shown below.

BS 5837:2012 Tree Quality Categories - Table 1

- Category A - High quality
- Category B - Moderate quality
- Category C - Low quality
- Category U - Unsuitable for retention

Tree protected by Tree Preservation Order. Bracketted number relates to the TPO reference.

NOTE:
 Refer to ES Appendix 8 to 11: Tree Survey report and Arboricultural Impact Assessment for further details.

DETAIL A

DETAIL B

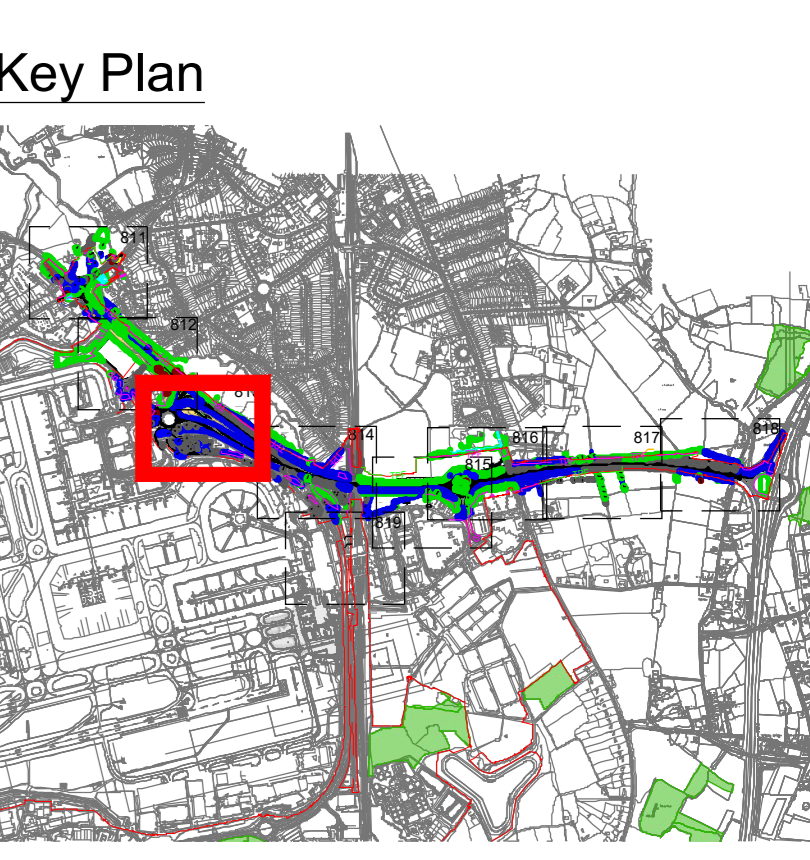

DOCUMENT

Environmental Statement

DRAWING TITLE
M23 & A23 Preliminary Tree Removal & Protection Plans
 Appendix 5.3.2 Annex 6
 Sheet 3 of 9

DATE
August 2024

ORIENTATION	DRAWING NO.	REVISION
N	813	For ES Issue
	DRAWN BY	PM / CHECKED BY
	RC	DC

SCALE @ A0
 0m 25m 50m

Reproduced from Ordnance Survey map with the permission of Ordnance Survey on behalf of the controller of Her Majesty's Stationery Office © Crown Copyright (2023). License number 010031673, 10001998, 100048492.
 © Copyright 2023 Gatwick Airport Limited. No part of this drawing is to be reproduced without prior permission of Gatwick Airport Limited.

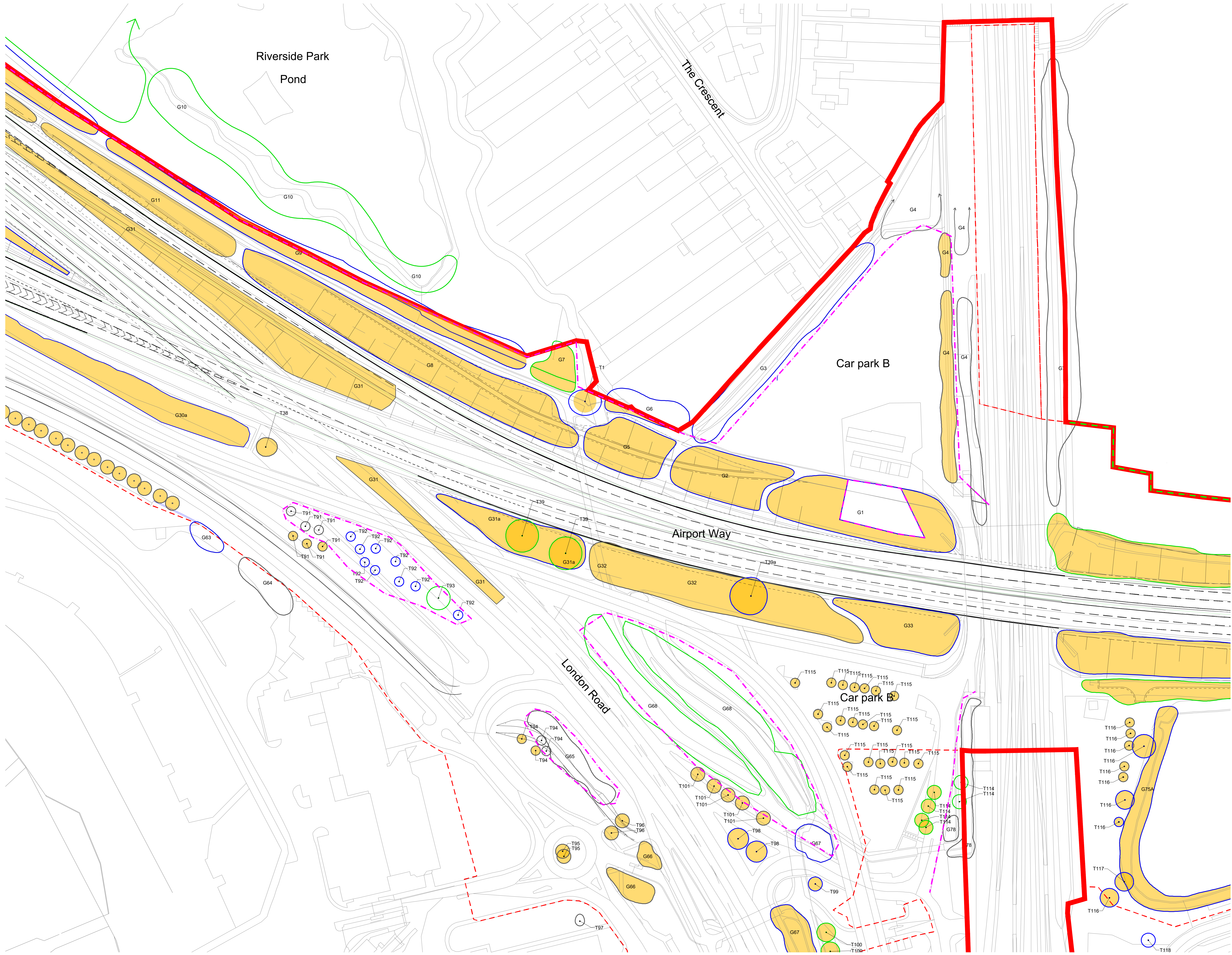

Key

- Site Boundary
- Survey Boundary / Boundary of M23/A23 construction activity
- Indicative temporary protective fence line in accordance with Section 6.2 - BS5837:2012. See below for example barriers.
- Indicative vegetation protective fence line: Design and location to be agreed by local council during detail design.
- Projected tree loss required for construction of the Project (worst case scenario)
- Tree with numbered reference. Canopy spread and coloured BS5837:2012 tree quality category as shown below.
 - Tree details estimate (inaccessible tree)
 - Tree in off site location
- Vegetation group with numbered reference. Canopy extents and BS5837:2012 tree quality category as shown below.
 - Width and BS5837:2012 tree quality category as shown below.
- Hedge with numbered reference. Width and BS5837:2012 tree quality category as shown below.

BS 5837:2012 Tree Quality Categories - Table 1

- Category A - High quality
- Category B - Moderate quality
- Category C - Low quality
- Category U - Unsuitable for retention

Tree protected by Tree Preservation Order. Bracketted number relates to the TPO reference.

NOTE:

- Refer to ES Appendix 8 to 10: Tree Survey report and Arboricultural Impact Assessment for further details.

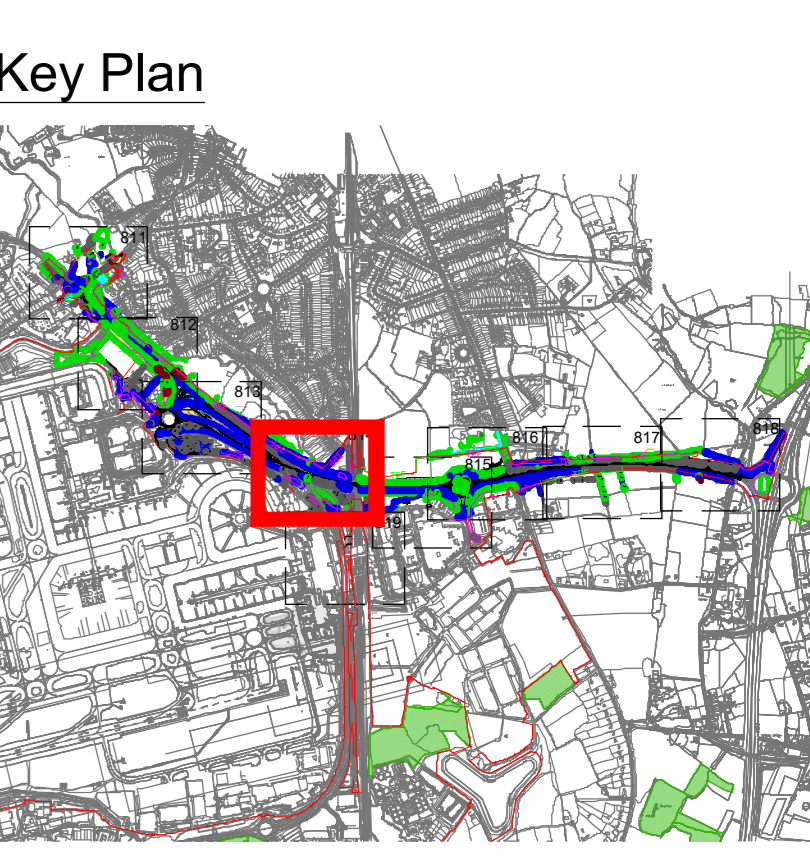
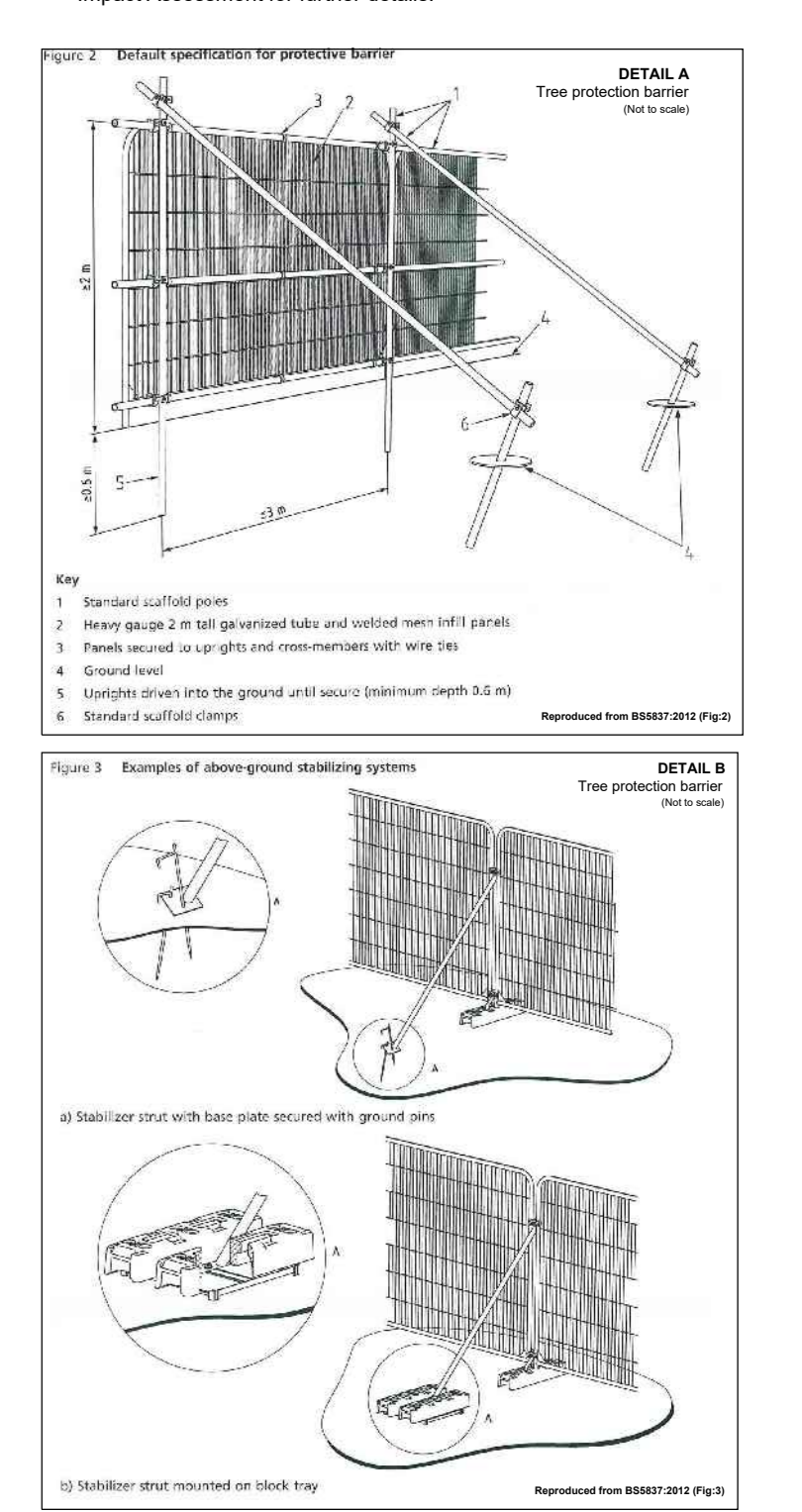

DOCUMENT

Environmental Statement





DRAWING TITLE
M23 & A23 Preliminary Tree Removal & Protection Plans
Appendix 5.3.2 Annex 6
Sheet 4 of 9

DATE
August 2024



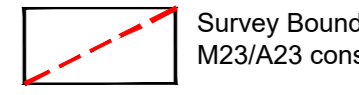
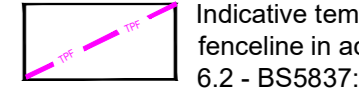
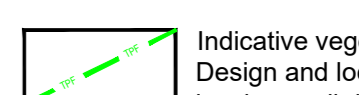
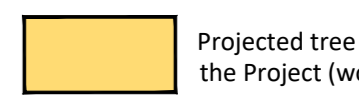

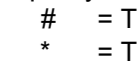
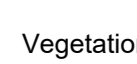
ORIENTATION	DRAWING NO.	REVISION
N	814	For ES Issue
	DRAWN BY RC	PM / CHECKED BY

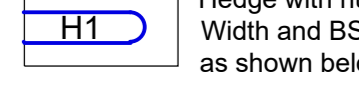
SCALE @ A0
0m 25m 50m

Key

-  Site Boundary
-  Survey Boundary / Boundary of M23/A23 construction activity
-  Indicative temporary protective fence line in accordance with Section 6.2 - BS5837:2012. See below for example barriers.
-  Indicative vegetation protective fence line: Design and location to be agreed by local council during detail design.
-  Projected tree loss required for construction of the Project (worst case scenario)
-  Tree with numbered reference. Canopy spread and coloured BS5837:2012 tree quality category as shown below.
 -  = Tree details estimate (accessible tree)
 -  = Tree in off site location
-  Vegetation group with numbered reference. Canopy extent and BS5837:2012 tree quality category as shown below.
-  Hedge with numbered reference. Width and BS5837:2012 tree quality category as shown below.

BS 5837:2012 Tree Quality Categories - Table 1

	Category A - High quality
	Category B - Moderate quality
	Category C - Low quality
	Category U - Unsuitable for retention

Tree protected by Tree Preservation Order. Bracketted number relates to the TPO reference.

NOTE:
 Refer to ES Appendix 8 to 11: Tree Survey report and Arboricultural Impact Assessment for further details.

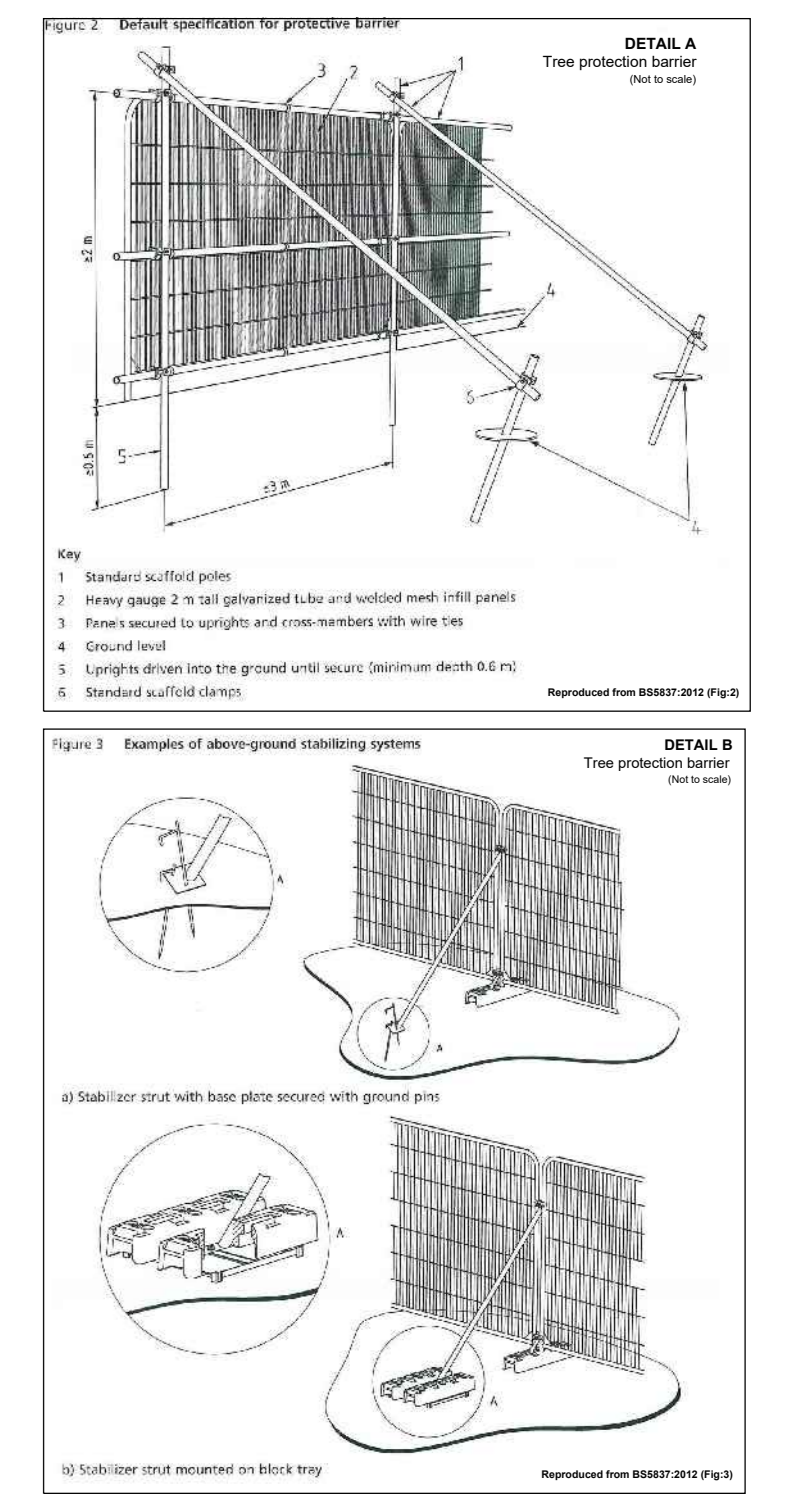

Key Plan

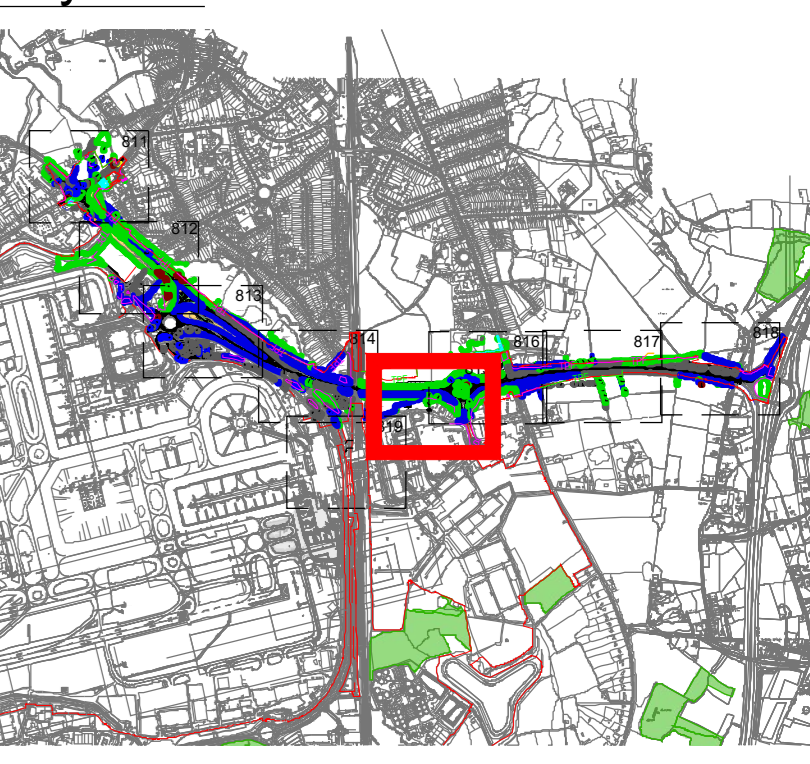

DOCUMENT

Environmental Statement

DRAWING TITLE
M23 & A23 Preliminary Tree Removal & Protection Plans
 Appendix 5.3.2 Annex 6
 Sheet 5 of 9

DATE
 August 2024

ORIENTATION N	DRAWING NO. 815	REVISION For ES Issue
	DRAWN BY RC	PM / CHECKED BY DC

SCALE @ A0
 0m 25m 50m

Reproduced from Ordnance Survey map with the permission of Ordnance Survey on behalf of the controller of Her Majesty's Stationery Office. © Crown Copyright (2023). License number 6100031673, 10004982, 10004982.
 © Copyright 2023 Gatwick Airport Limited. No part of this drawing is to be reproduced without prior permission of Gatwick Airport Limited.

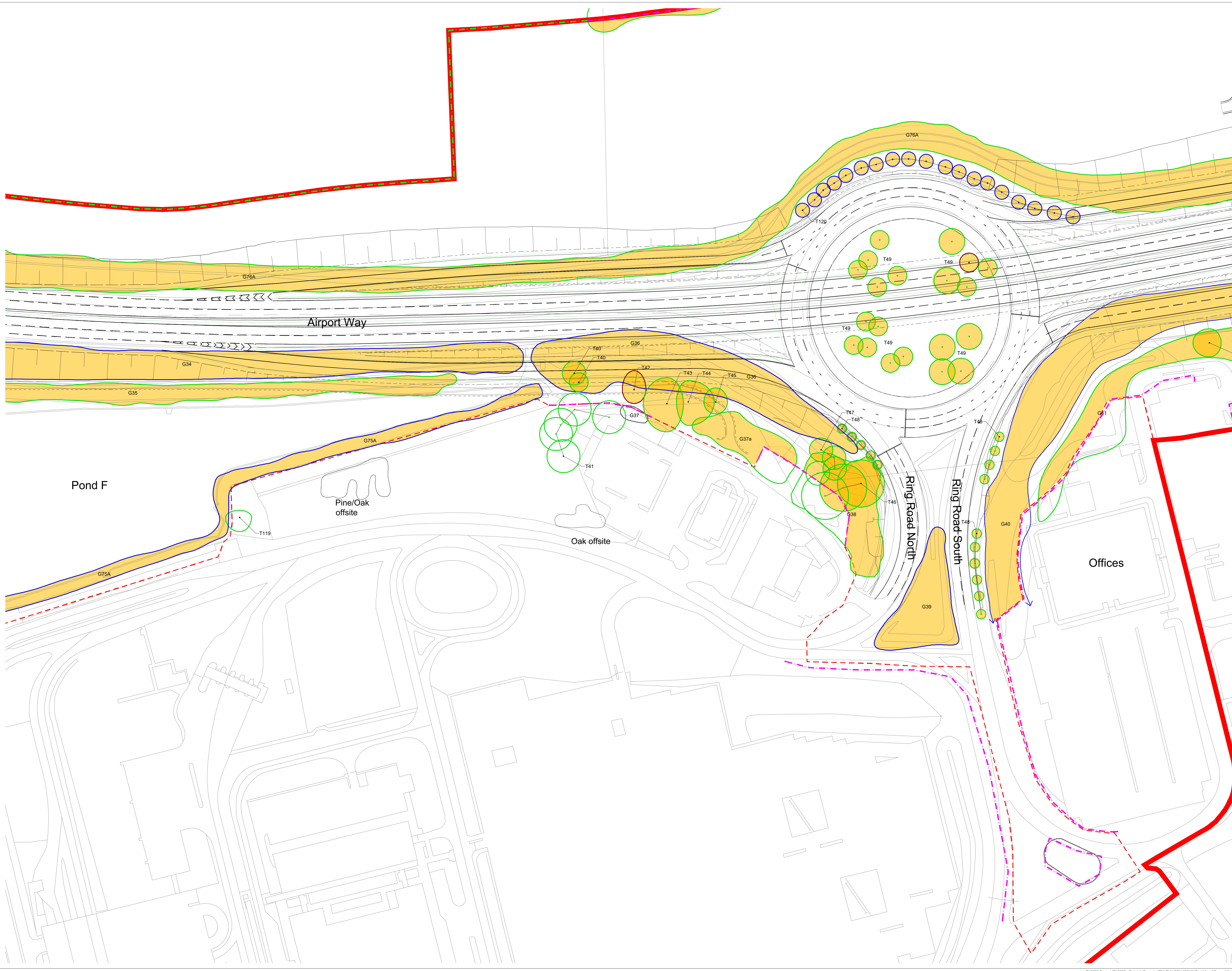

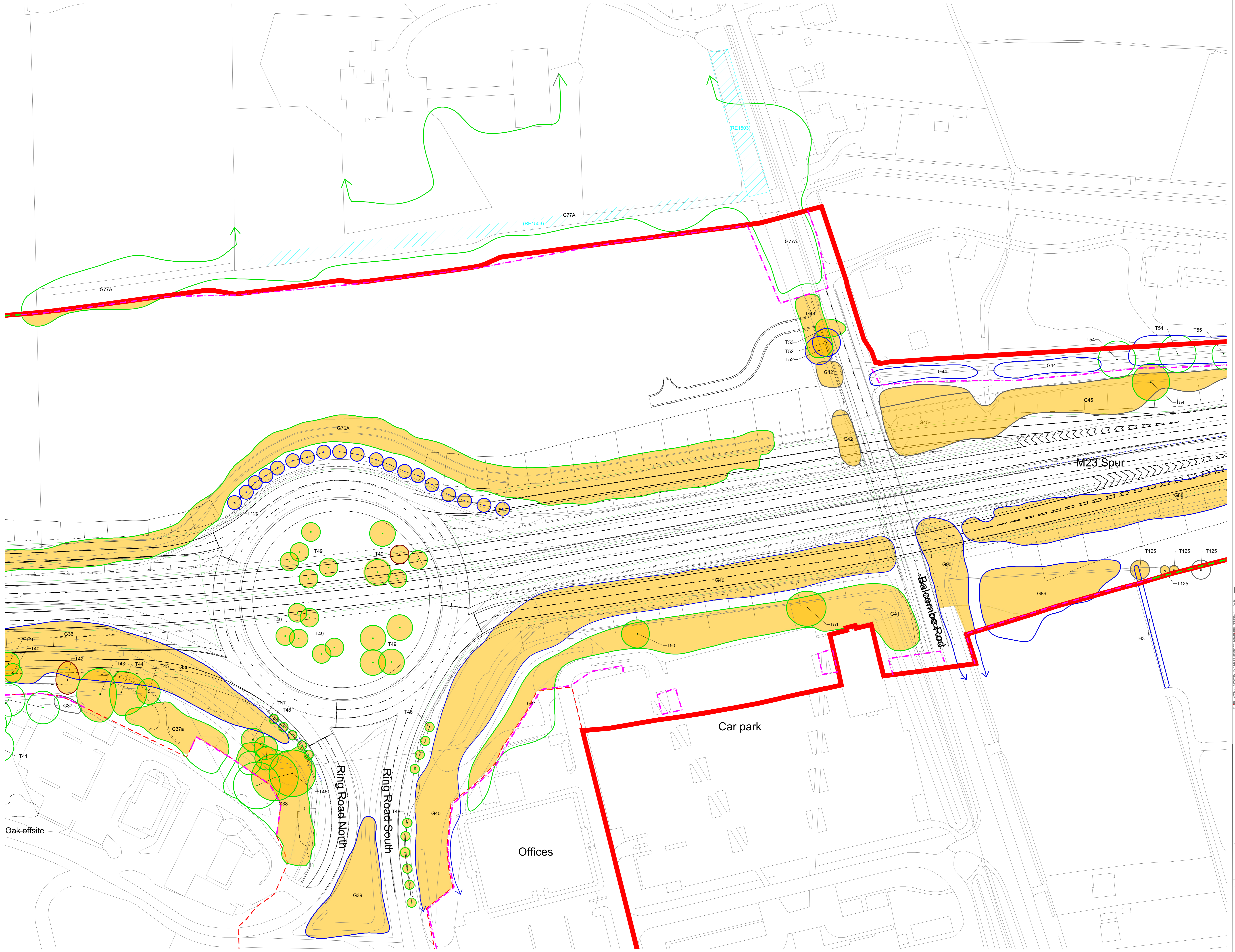

Key

- Site Boundary
- Survey Boundary / Boundary of M23/A23 construction activity
- Indicative temporary protective fence line in accordance with Section 6.2 - BS5837:2012. See below for example barriers.
- Indicative vegetation protective fence line: Design and location to be agreed by local council during detail design.
- Projected tree loss required for construction of the Project (worst case scenario)
- Tree with numbered reference. Canopy spread and coloured BS5837:2012 tree quality category as shown below.
 - = Tree details estimate (inaccessible tree)
 - = Tree in off site location
- Vegetation group with numbered reference. Canopy extents and BS5837:2012 tree quality category as shown below.
- Hedge with numbered reference. Width and BS5837:2012 tree quality category as shown below.
- Tree protected by Tree Preservation Order. Bracketted number relates to the TPO reference.

BS 5837:2012 Tree Quality Categories - Table 1

- Category A - High quality
- Category B - Moderate quality
- Category C - Low quality
- Category U - Unsuitable for retention

NOTE:

- Refer to ES Appendix 8.10.1: Tree Survey report and Arboricultural Impact Assessment for further details.

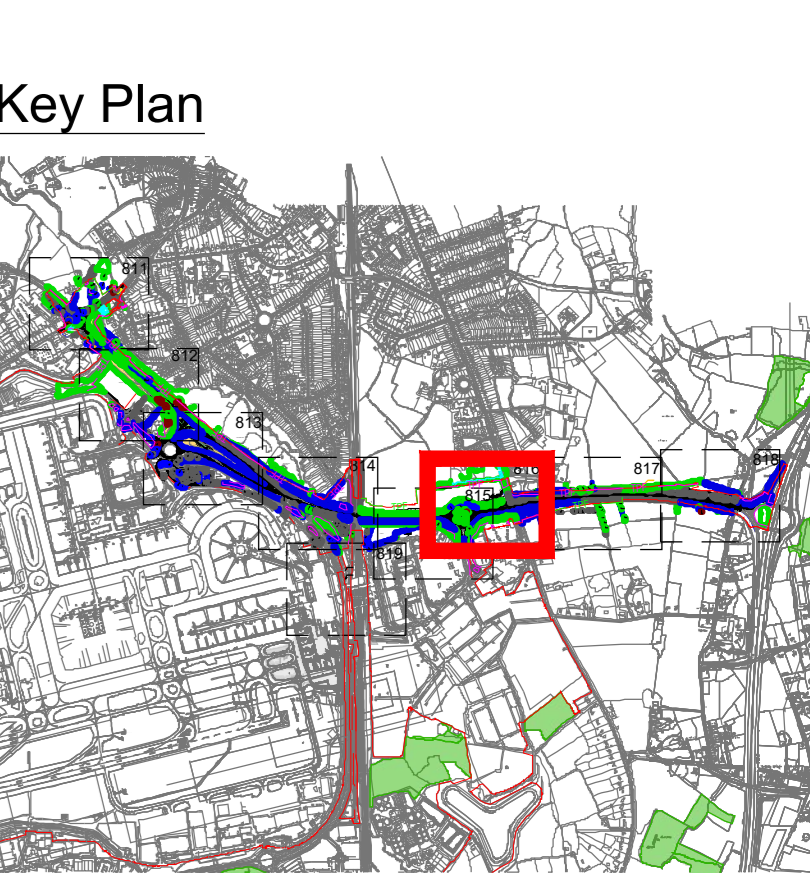
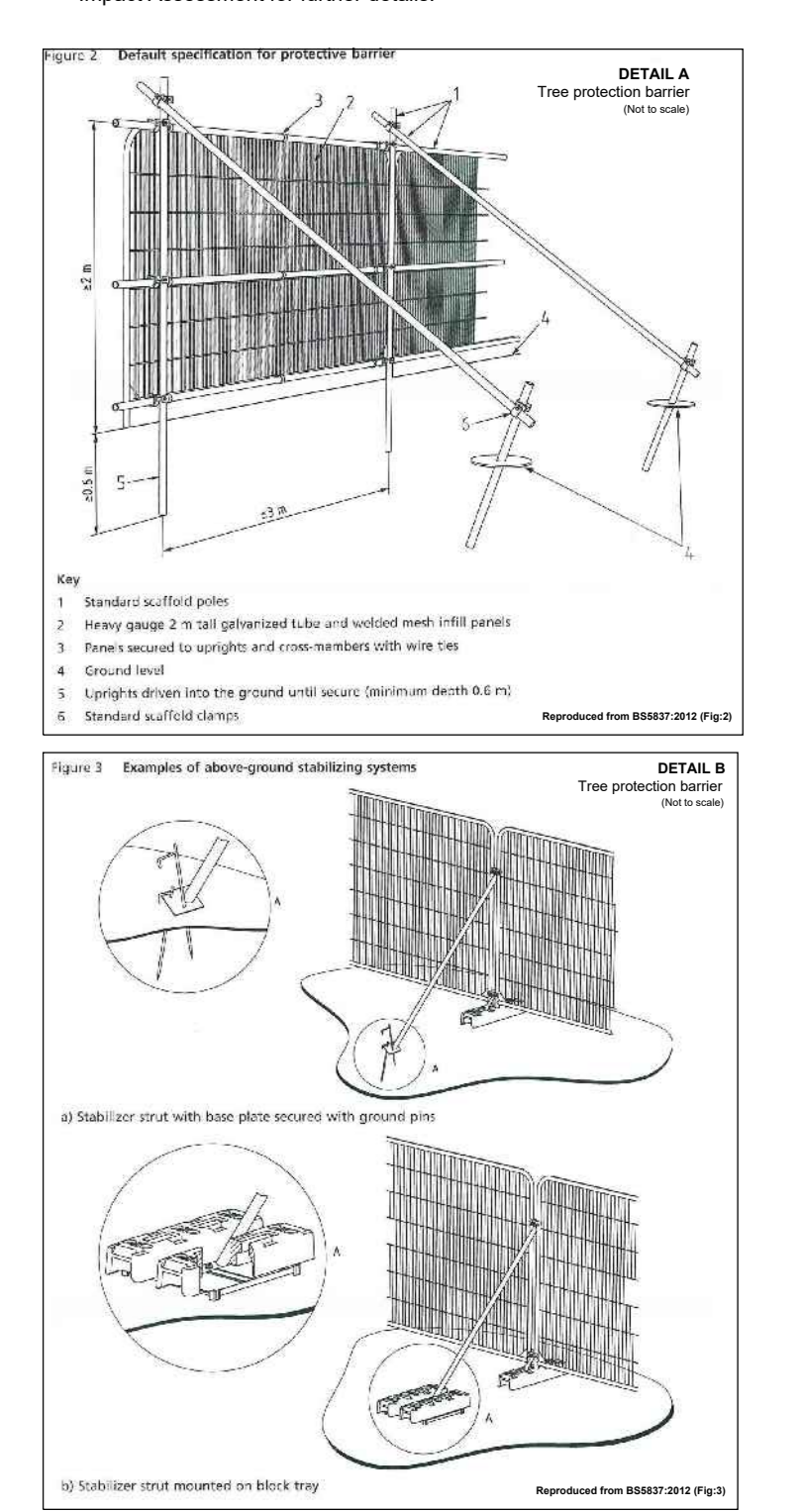

DOCUMENT

Environmental Statement

DRAWING TITLE
M23 & A23 Preliminary Tree Removal & Protection Plans
 Appendix 5.3.2 Annex 6
 Sheet 6 of 9

DATE
 August 2024

ORIENTATION	DRAWING NO.	REVISION
N	816	For ES Issue
	DRAWN BY	PM / CHECKED BY
	RC	DC

SCALE @ A0
 0m 25m 50m

Reproduced from Ordnance Survey map with the permission of Ordnance Survey on behalf of the controller of Her Majesty's Stationery Office © Crown Copyright (2023). License number 610031673, 10001998, 100048492.
 © Copyright 2023 Gatwick Airport Limited. No part of this drawing is to be reproduced without prior permission of Gatwick Airport Limited.

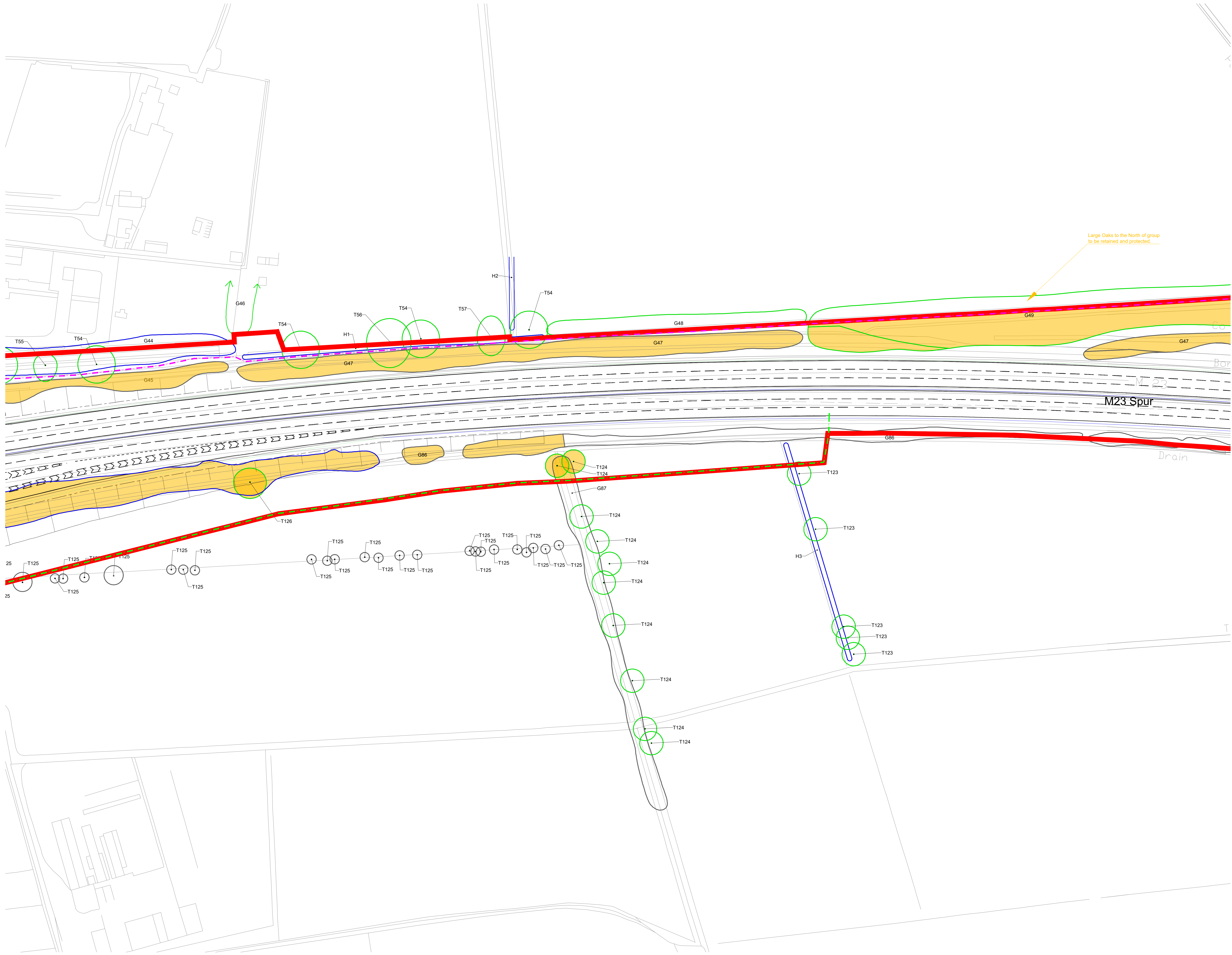

Key

- Site Boundary
- Survey Boundary / Boundary of M23/A23 construction activity
- Indicative temporary protective fence line in accordance with Section 6.2 - BS5837:2012. See below for example barriers.
- Indicative vegetation protective fence line: Design and location to be agreed by local council during detail design.
- Projected tree loss required for construction of the Project (worst case scenario)
- Tree with numbered reference. Canopy spread and coloured BS5837:2012 tree quality category as shown below.
 - = Tree details estimate (accessible tree)
 - = Tree in off site location
- Vegetation group with numbered reference. Canopy extents and BS5837:2012 tree quality category as shown below.
- Hedge with numbered reference. Width and BS5837:2012 tree quality category as shown below.

BS 5837:2012 Tree Quality Categories - Table 1

- Category A - High quality
- Category B - Moderate quality
- Category C - Low quality
- Category U - Unsuitable for retention

Tree protected by Tree Preservation Order. Bracketted number relates to the TPO reference.

NOTE:

- Refer to ES Appendix 8 to 1: Tree Survey report and Arboricultural Impact Assessment for further details.

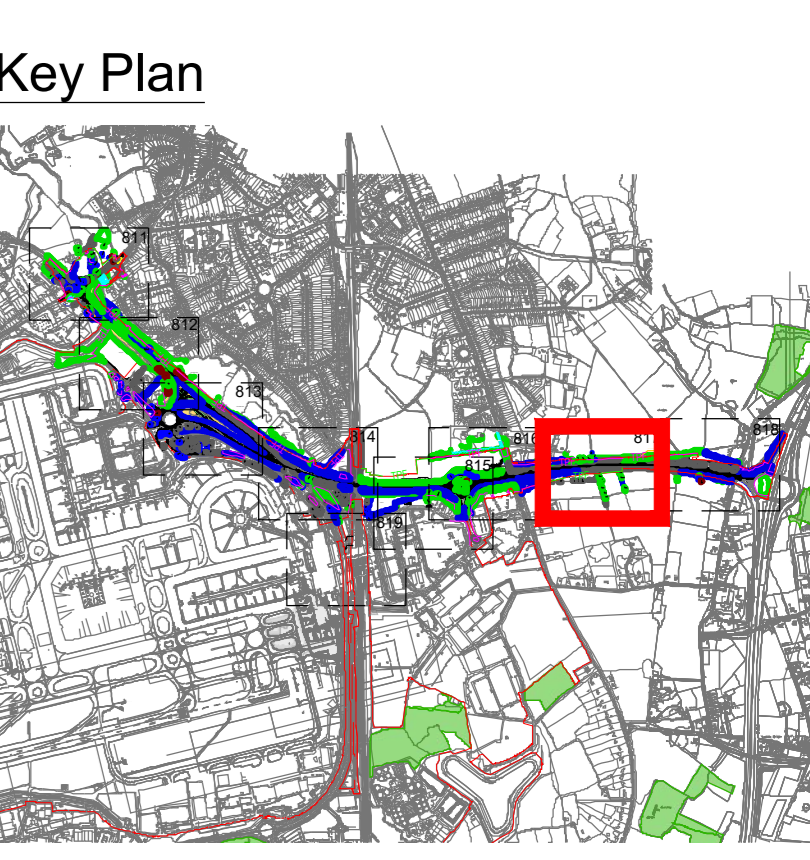
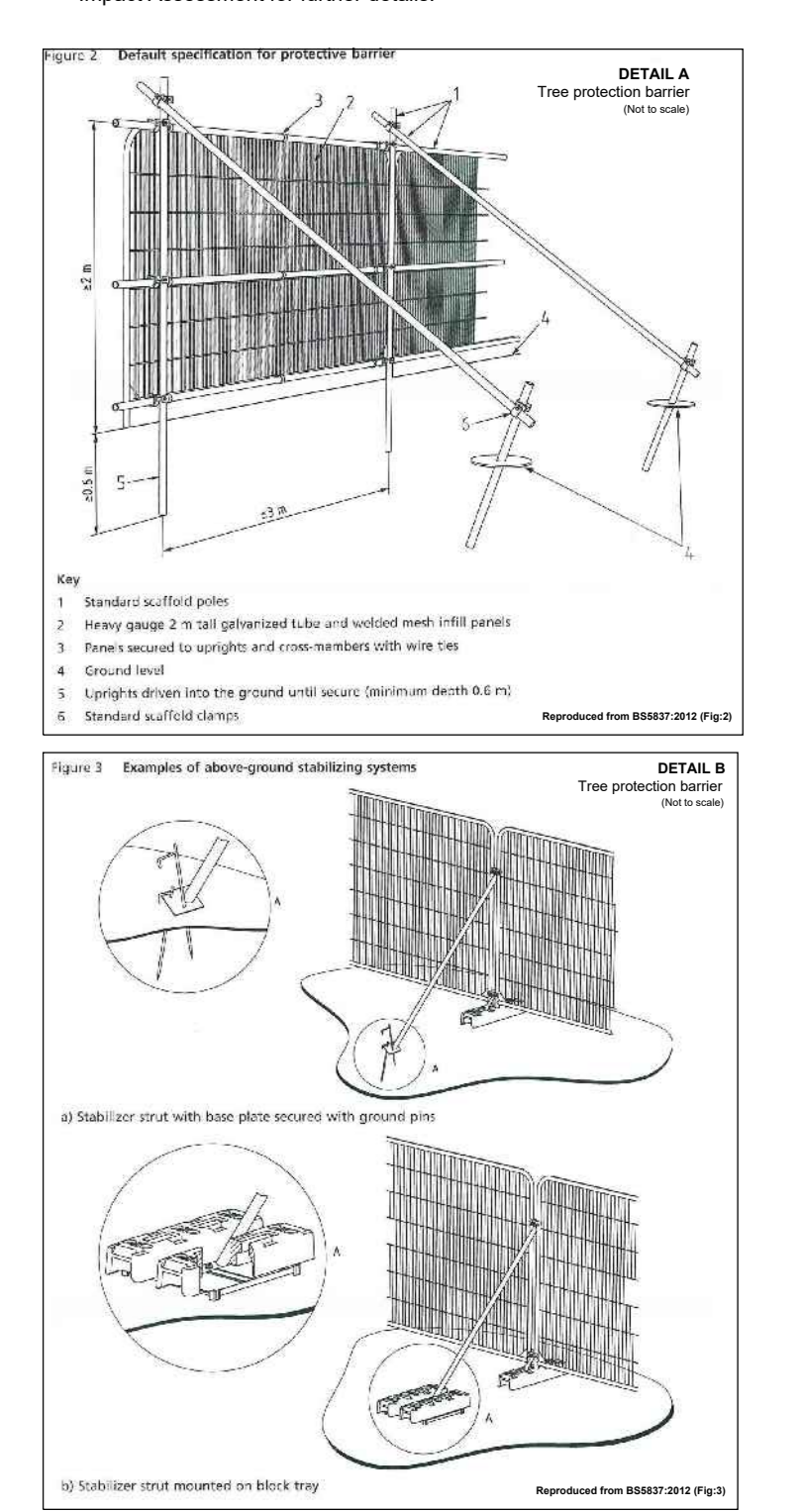

DOCUMENT

Environmental Statement

DRAWING TITLE
M23 & A23 Preliminary Tree Removal & Protection Plans
 Appendix 5.3.2 Annex 6
 Sheet 7 of 9

DATE
 August 2024

ORIENTATION N	DRAWING NO. 817	REVISION For ES Issue
	DRAWN BY RC	PM / CHECKED BY DC

SCALE @ A0
 0m 25m 50m

Reproduced from Ordnance Survey map with the permission of Ordnance Survey on behalf of the controller of Her Majesty's Stationery Office © Crown Copyright (2023). License number 6100031673, 10004986, 10004982.
 © Copyright 2023 Gatwick Airport Limited. No part of this drawing is to be reproduced without prior permission of Gatwick Airport Limited.

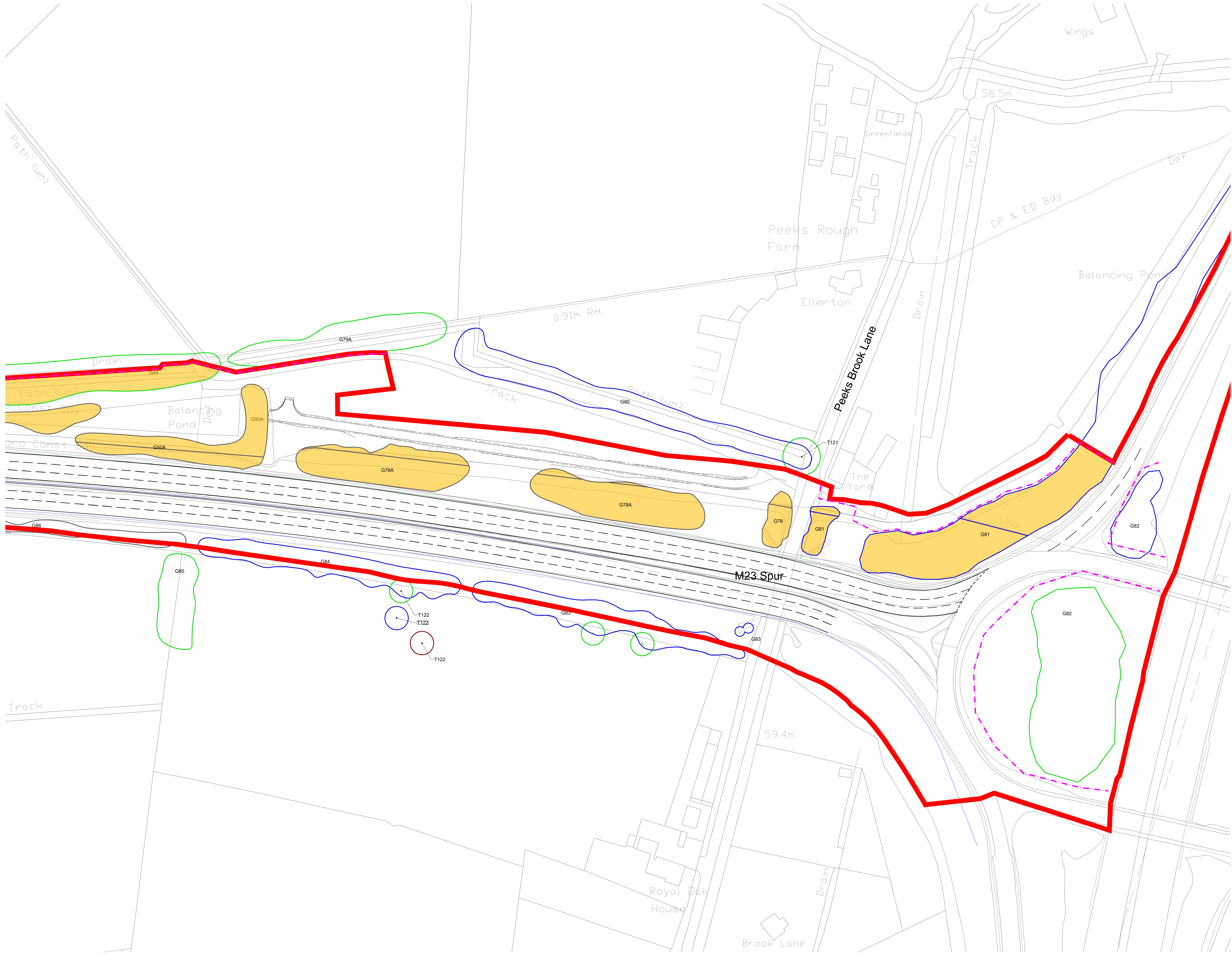

Key

- Site Boundary
- Survey Boundary / Boundary of M23/A23 construction activity
- Indicative temporary protective fence line in accordance with Section 6.2 - BS5837:2012. See below for example barriers.
- Indicative vegetation protective fence line: Design and location to be agreed by local council during detail design.
- Projected tree loss required for construction of the Project (worst case scenario)
- Tree with numbered reference. Canopy spread and coloured BS5837:2012 tree quality category as shown below.
 - = Tree details estimate (accessible tree)
 - = Tree in off site location
- Vegetation group with numbered reference. Canopy spread and coloured BS5837:2012 tree quality category as shown below.
- Hedge with numbered reference. Width and BS5837:2012 tree quality category as shown below.

BS 5837:2012 Tree Quality Categories - Table 1

- Category A - High quality
- Category B - Moderate quality
- Category C - Low quality
- Category U - Unsuitable for retention

Tree protected by Tree Preservation Order. Bracketted number relates to the TPO reference.

NOTE:

- Refer to ES Appendix 8 to 1: Tree Survey report and Arboricultural Impact Assessment for further details.

DETAIL A

DETAIL B

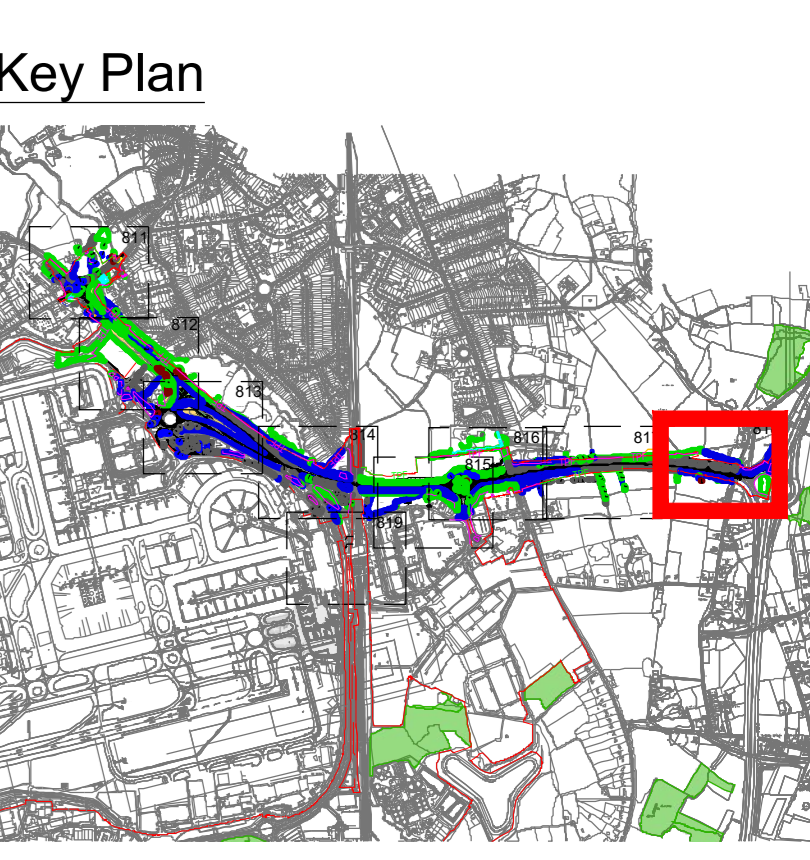

DOCUMENT

Environmental Statement

DRAWING TITLE
M23 & A23 Preliminary Tree Removal & Protection Plans
 Appendix 5.3.2 Annex 6
 Sheet 8 of 9

DATE
 August 2024

ORIENTATION N	DRAWING NO. 818	REVISION For ES Issue
	DRAWN BY RC	PM / CHECKED BY DC

SCALE @ A0
 0m 25m 50m

Reproduced from Ordnance Survey map with the permission of Ordnance Survey on behalf of the controller of Her Majesty's Stationery Office © Crown Copyright (2023). License number 6100031673, 10001998, 100048492.
 © Copyright 2023 Gatwick Airport Limited. No part of this drawing is to be reproduced without prior permission of Gatwick Airport Limited.

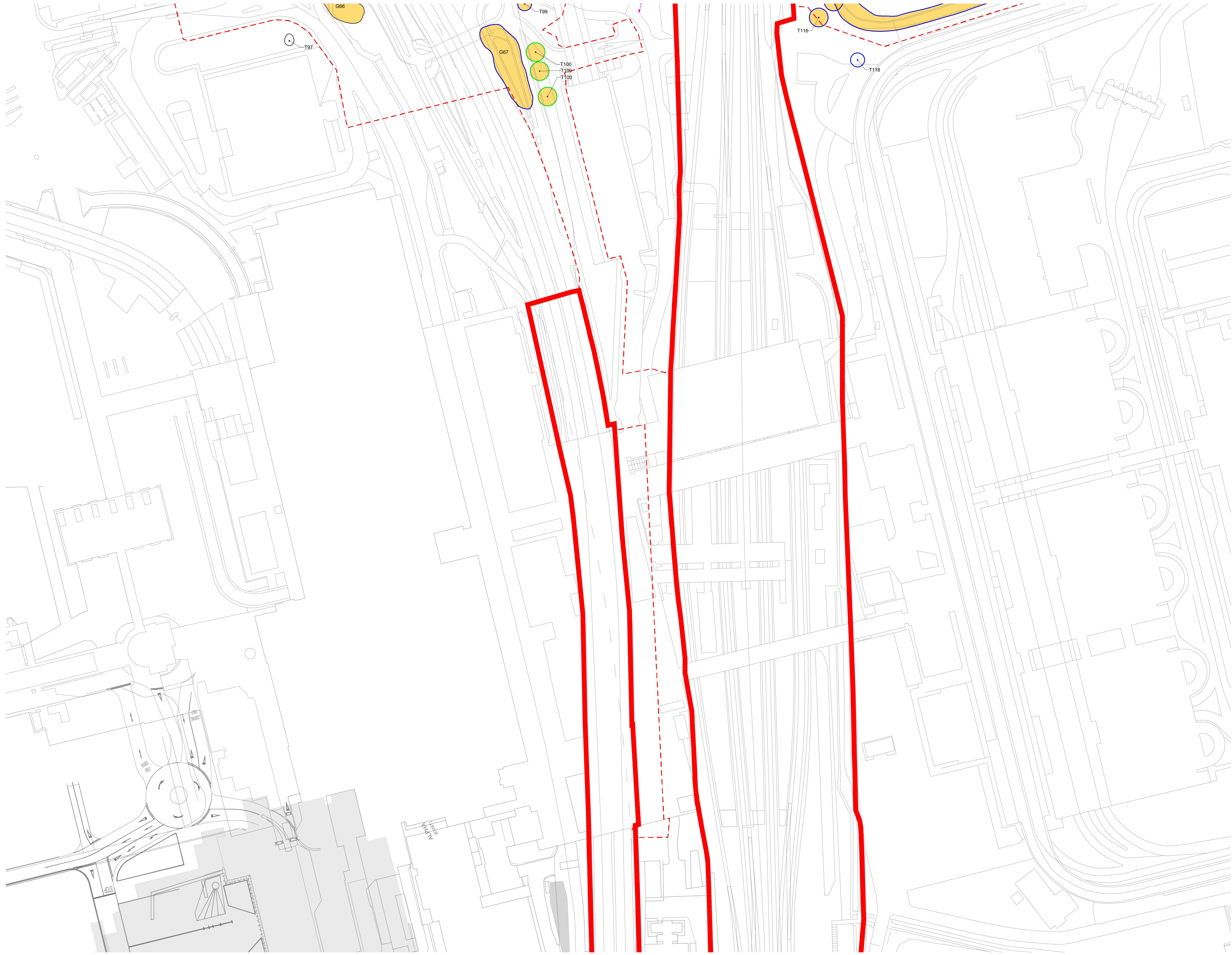

Key

- Site Boundary
- Survey Boundary / Boundary of M23/A23 construction activity
- Indicative temporary protective fence line in accordance with Section 6.2 - BS5837:2012. See below for example barriers.
- Indicative vegetation protective fence line: Design and location to be agreed by local council during detail design.
- Projected tree loss required for construction of the Project (worst case scenario)
- Tree with numbered reference. Canopy spread and coloured BS5837:2012 tree quality category as shown below.
 - = Tree details estimate (accessible tree)
 - = Tree in off site location
- Vegetation group with numbered reference. Canopy extents and BS5837:2012 tree quality category as shown below.
- Hedge with numbered reference. Width and BS5837:2012 tree quality category as shown below.

BS 5837:2012 Tree Quality Categories - Table 1

- Category A - High quality
- Category B - Moderate quality
- Category C - Low quality
- Category U - Unsuitable for retention

Tree protected by Tree Preservation Order. Bracketted number relates to the TPO reference.

NOTE:

- Refer to ES Appendix 8 to 10: Tree Survey report and Arboricultural Impact Assessment for further details.

Figure 2: Details of protective barriers

Key:

1. Barbed top rail pipes
2. Intermediate rail of high tensile material and subject to 10% deflection
3. Posts secured in upright and interconnected with tie
4. Ground fast
5. Length of tie line the general rule is 1m or 1.5m or 2.0m
6. Barbed bottom rail pipe

Figure 3: Examples of alternative detailing systems

Key:

1. Alternative detailing system
2. Alternative detailing system
3. Alternative detailing system
4. Alternative detailing system
5. Alternative detailing system
6. Alternative detailing system

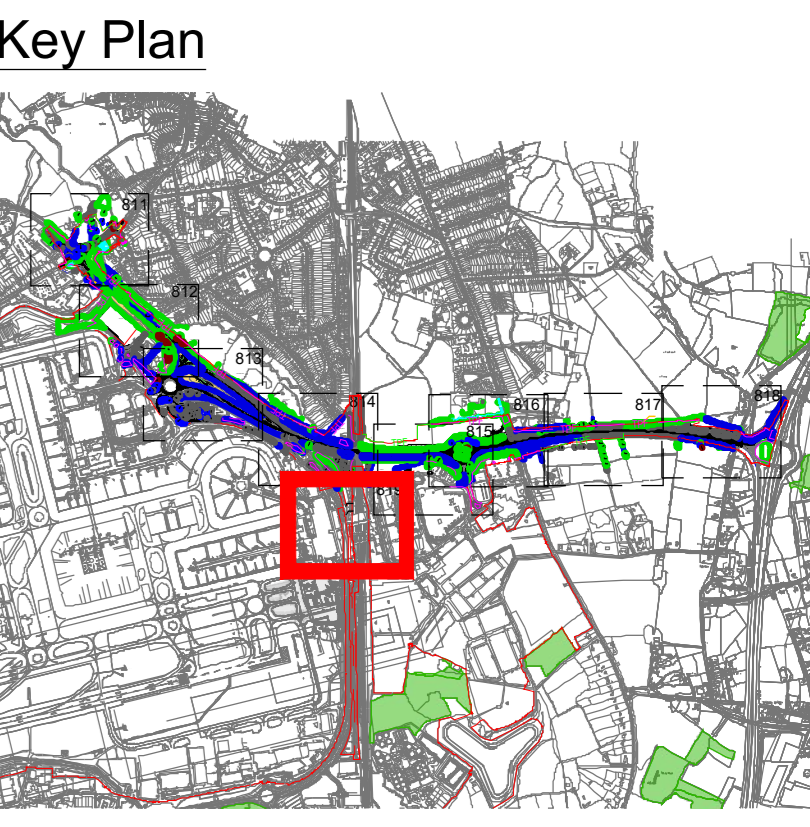

DOCUMENT

Environmental Statement

DRAWING TITLE
M23 & A23 Preliminary Tree Removal & Protection Plans
Appendix 5.3.2 Annex 6
Sheet 9 of 9

DATE
August 2024

ORIENTATION	DRAWING NO. 819	REVISION For ES Issue
	DRAWN BY RC	PM / CHECKED BY DC

SCALE @ A0
0m 25m 50m

Reproduced from Ordnance Survey map with the permission of Ordnance Survey on behalf of the controller of Her Majesty's Stationery Office © Crown Copyright (2023). License number 6100031673, 10001998, 10004892.
© Copyright 2023 Gatwick Airport Limited. No part of this drawing is to be reproduced without prior permission of Gatwick Airport Limited.

Appendix B
Airport Preliminary Tree Removal & Protection Plans